

Entropy in Metabolism and the Emergence of Complex Structures

Oliver Ebenhöf

Overview: Ongoing research



Designing Starch ERA-CAPS

- Explain polymer biochemistry with statistical thermodynamics
- Understand the formation of a starch granule

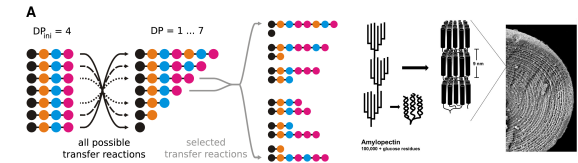

(Kartal et al, 2011; Ebenhöh et al, 2013; Ruzanski et al, 2013)

Photosynthetic Acclimation

- Understand the regulation of photosynthesis
- Nonphotochemical quenching, state transitions

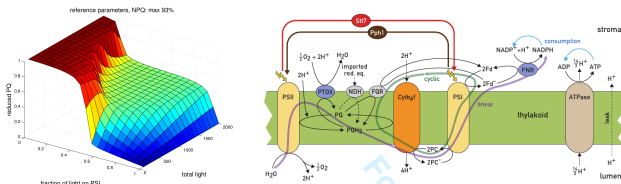

(Ebenhöh et al, 2011; Ebenhöh et al, 2014; Matuszyńska et al, 2015)

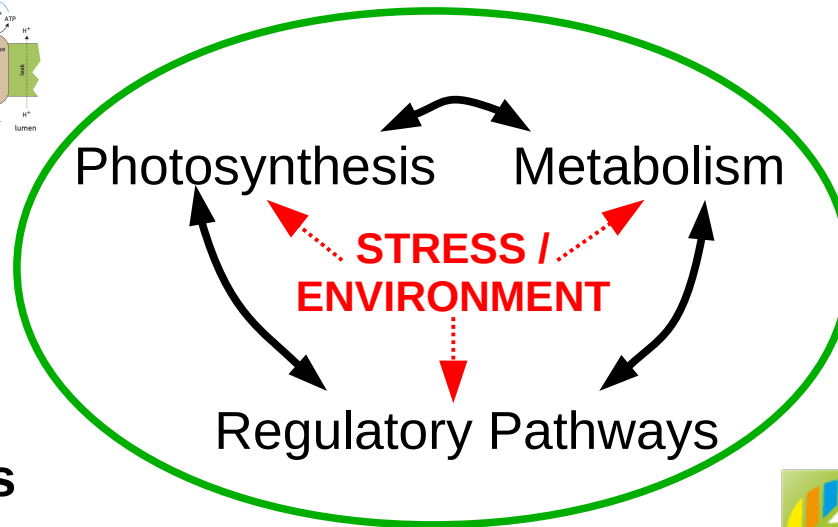

BioSC Algal Fertilizers

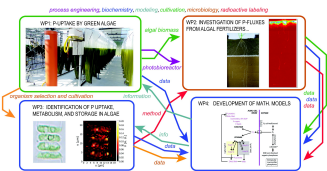

- Understand phosphate uptake and storage metabolism in plants and algae
- Use algae to extract P from wastewater and apply as fertilizer to soil



Secondary metabolism

- Understand what controls the diversity of secondary metabolite structures
- Glucosinolates
- Fatty acids / designer oils



Starch – half the caloric uptake of humanity



pictures from:

1 – cropsforthefuture.org / commons.wikimedia.org (Author: NusHub)
2 – nutr130.wikispaces.com
3 – nutr130.wikispaces.com
4 – newworldencyclopedia.org

5 – freefoodfotos.com
6 – commons.wikimedia.org (Author: KATORISI)
7 – mappingignorace.org (Sanjeev Gupta / EPA)
8 – commons.wikimedia.org (Author: P. Brundel)

Why starch?

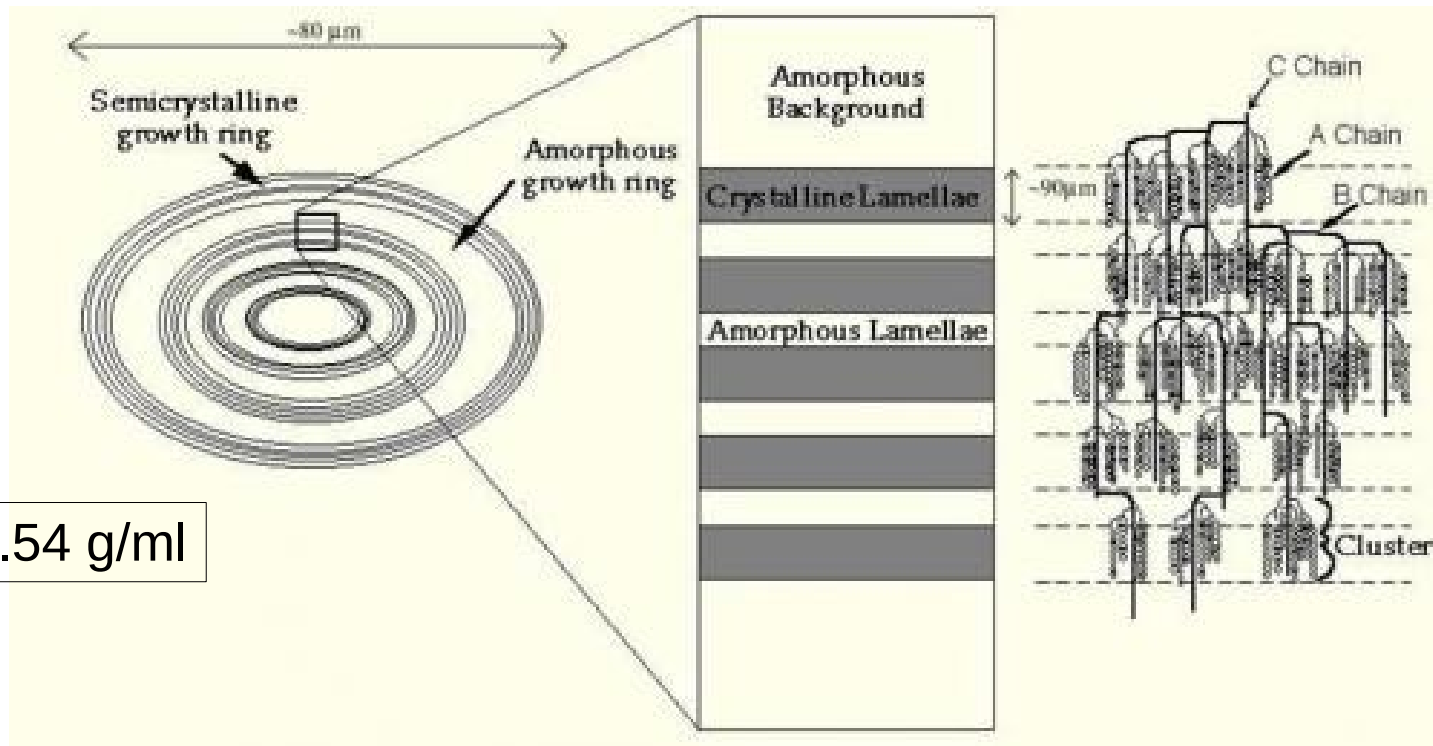
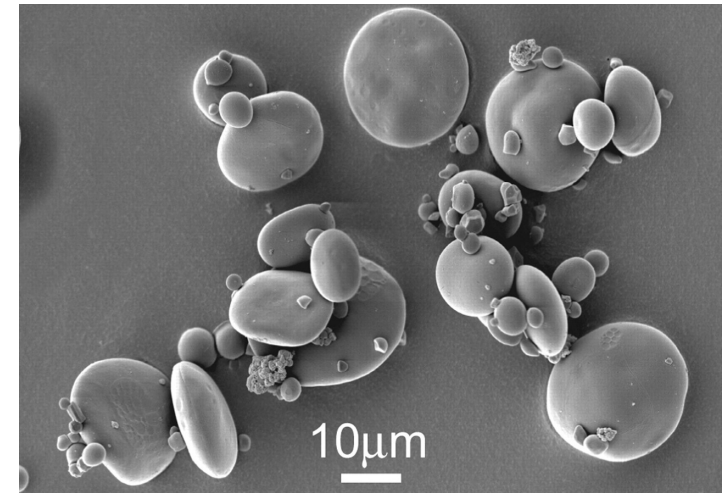
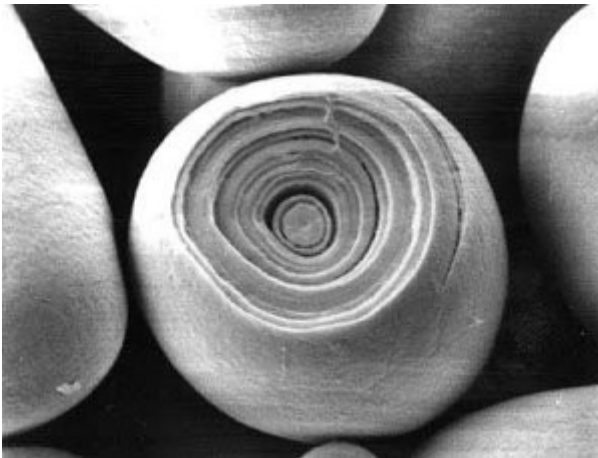

Density: 1.54 g/ml

The structure of starch allows for an extremely high energy storage density

Alternatives

energy content (kJ/g)

Carbohydrates	17
Lipids	38
Proteins	17
Alcohol	30

We (animals and fungi)
predominantly use glycogen



Possible advantages of starch

- low osmolarity
- large size
- high density

big molecule (up to 10 MDa)

still small compared to starch

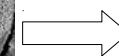
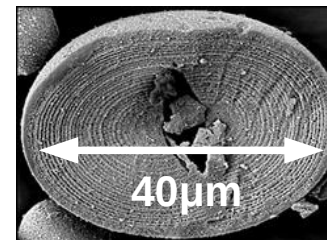

$3 \cdot 10^{10}$ Da!!!

Alternatives

energy content (kJ/g)

Carbohydrates	17
Lipids	38
Proteins	17
Alcohol	30

We (animals and fungi) predominantly use glycogen

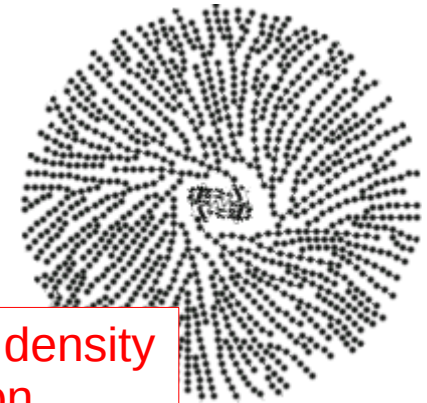

trade-off between storage density and rapid mobilization

big molecule (up to 10 MDa)

Possible advantages of starch

- low osmolarity
- large size
- high density

still small compared to starch

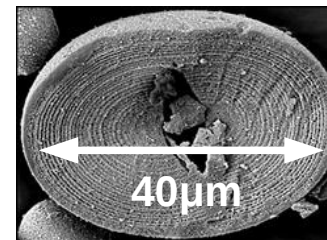

$3 \cdot 10^{10}$ Da!!!

optimised for storage density, slower deployment

The structure of a starch granule

Amylose
(MW 32,000-113,000)

Amylopectin
(MW 10^7 - 10^9)

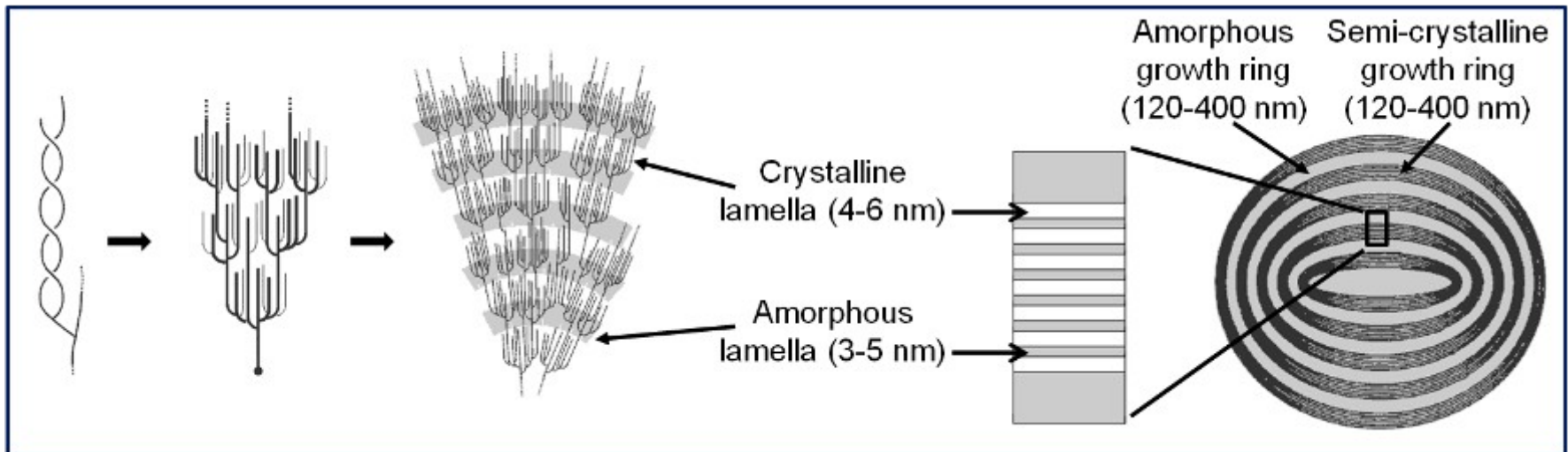
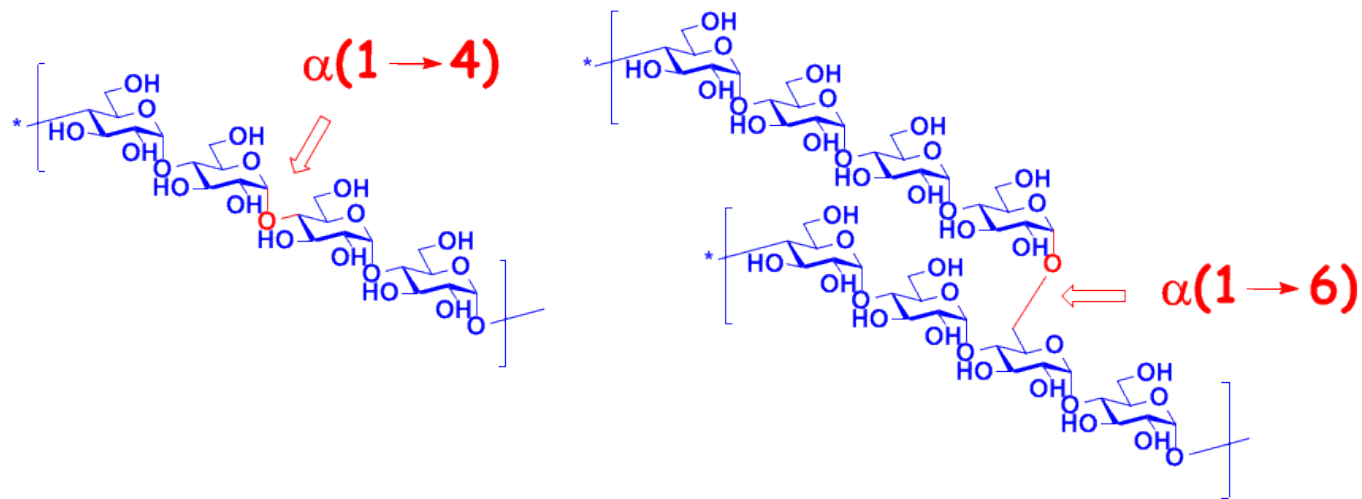

Wouldn't it be great...

...if we could design starch with desired properties *in vivo*?

But how do all these factors actually play together?

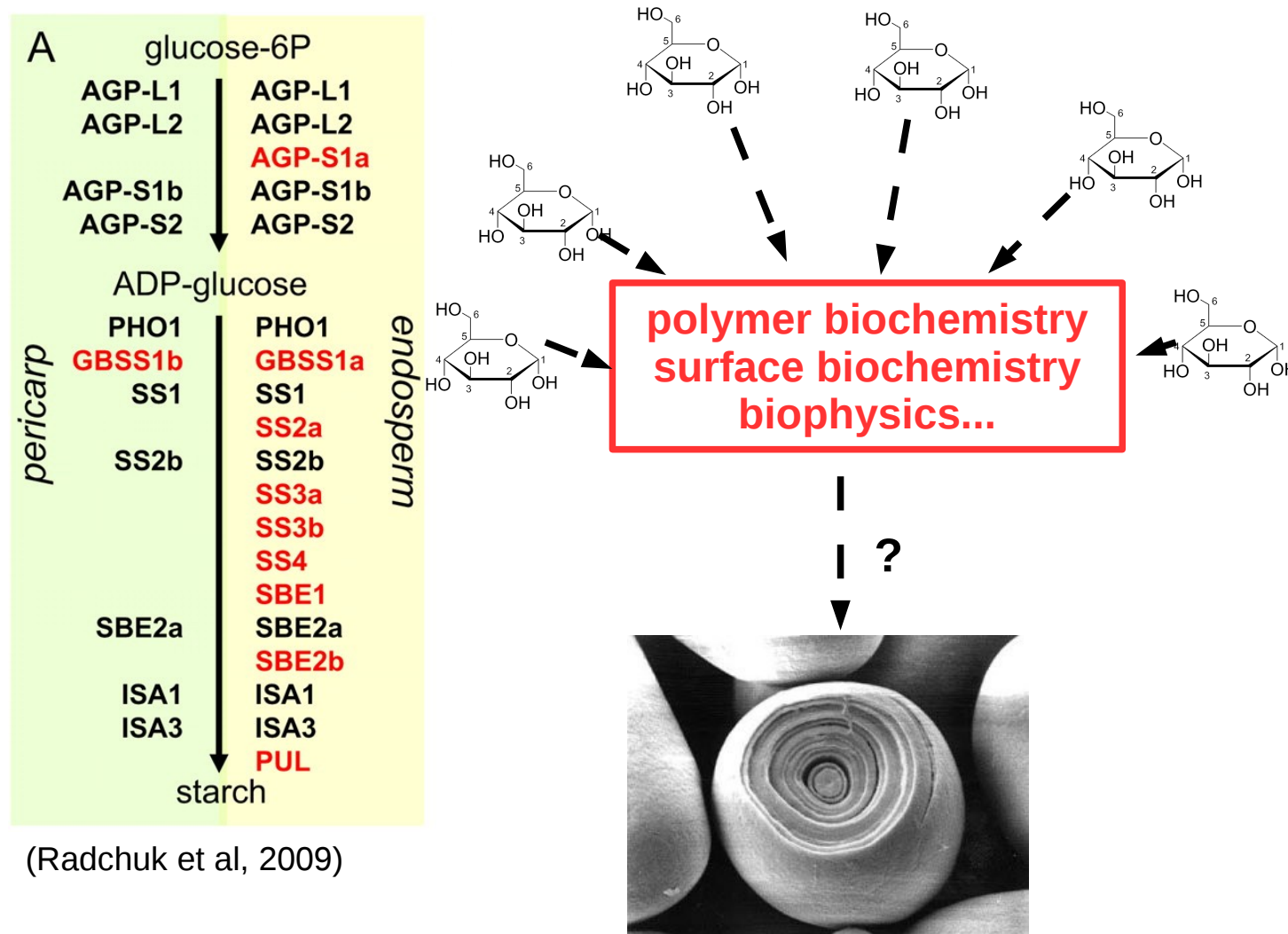

(Radchuk et al, 2009)

Wouldn't it be great...

...if we could design starch with desired properties *in vivo*?

But how do all these factors actually play together?

Most of the involved enzymes have homologs in glycogen metabolism!

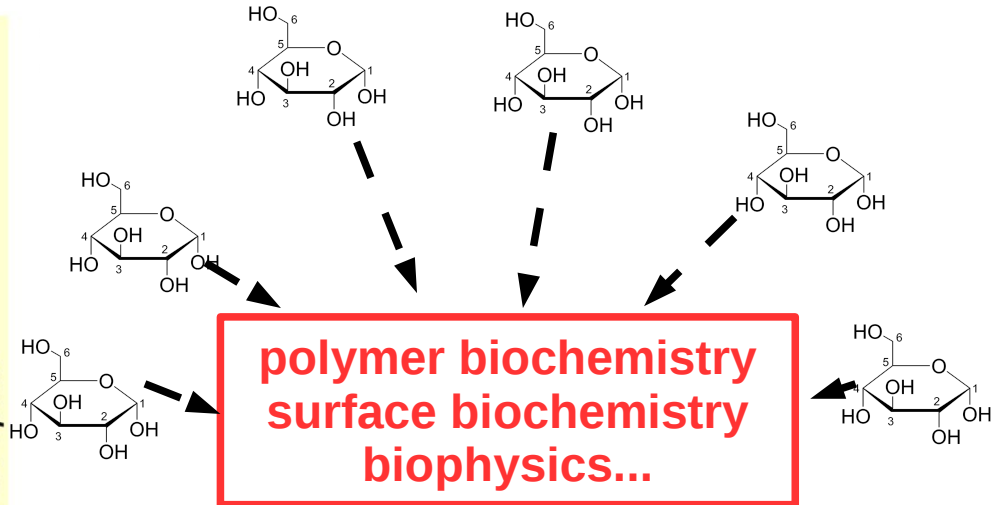
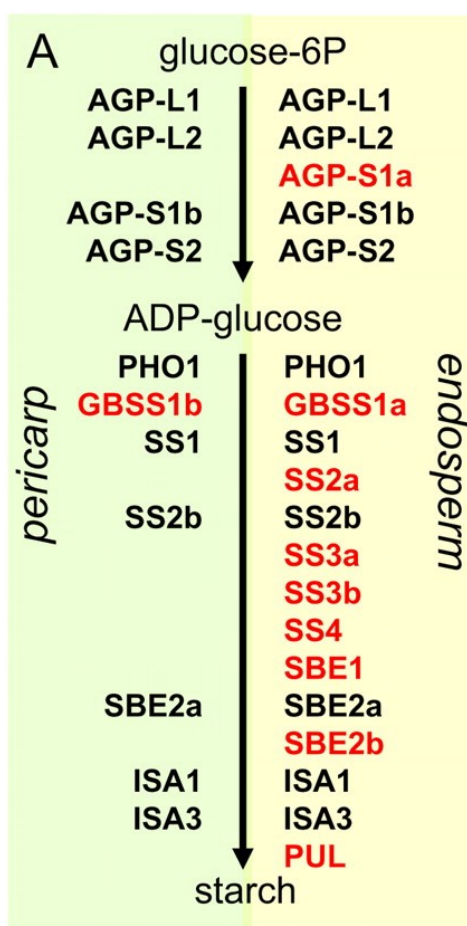

↓
?

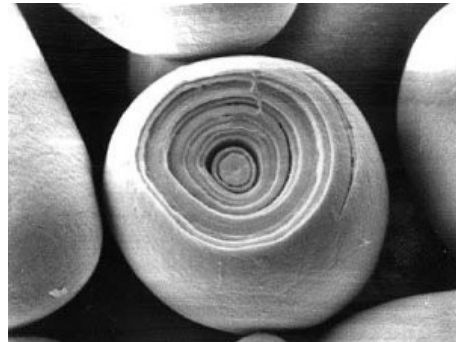

(Radchuk et al, 2009)

A classical physics problem

molecular interactions

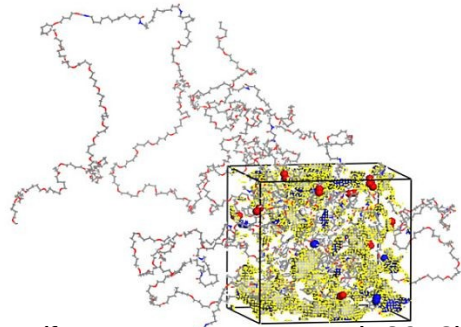

(from: De Lorenzo et al, 2012)

gas

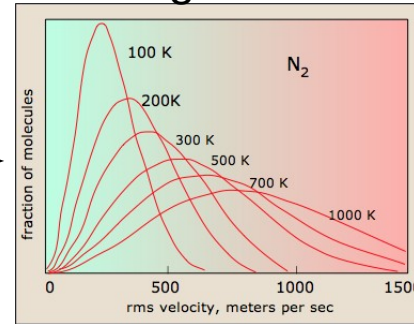

(from: chemwiki.udavies.edu)

collective behaviour

- pressure
- temperature

microscopic

macroscopic scale

PHYSICS

BIOLOGY

enzymes
surface physics
polymer chemistry

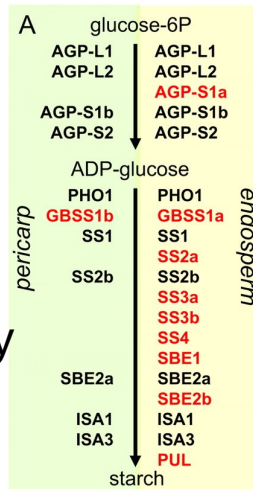

(from: Radchuk et al, 2009)

starch granule

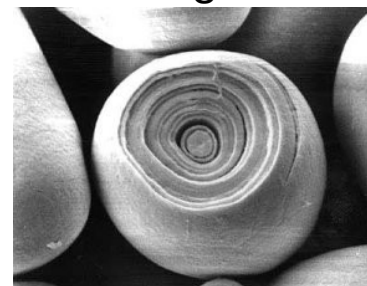

(from: braukaiser.com)

- chain length distr.
- branching pattern
- glycaemic index

TOP-DOWN OR BOTTOM-UP?



DesignStarch

ERA-NET for Coordinating
Action in Plant Sciences

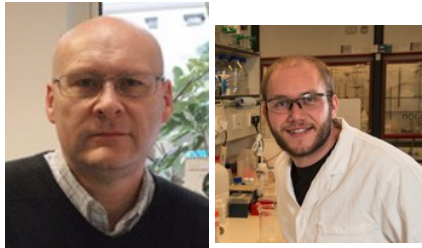

**Rob Field, Michael Rugen
(JIC Norwich)**

Biochemistry WP1
Isolation/characterisation of parts
Artificial, controlled in vitro systems

Theory WP4
Mathematical models
Theoretical concepts
Computational predictions
Understanding of emergent properties

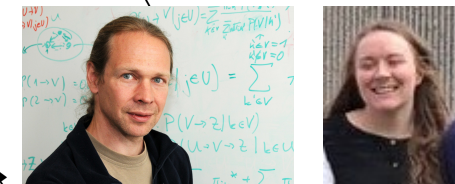

Systemic WP3
Genetic modifications in planta
Phenotypic characterisation

Synthetic WP2
Expression of enzymes in yeast
Reconstitution of artificial systems



**Sam Zeeman, Barbara Pfister
(ETH Zurich)**

**Oliver Ebenhöf, Adélaïde Raguin
(HHU Düsseldorf)**

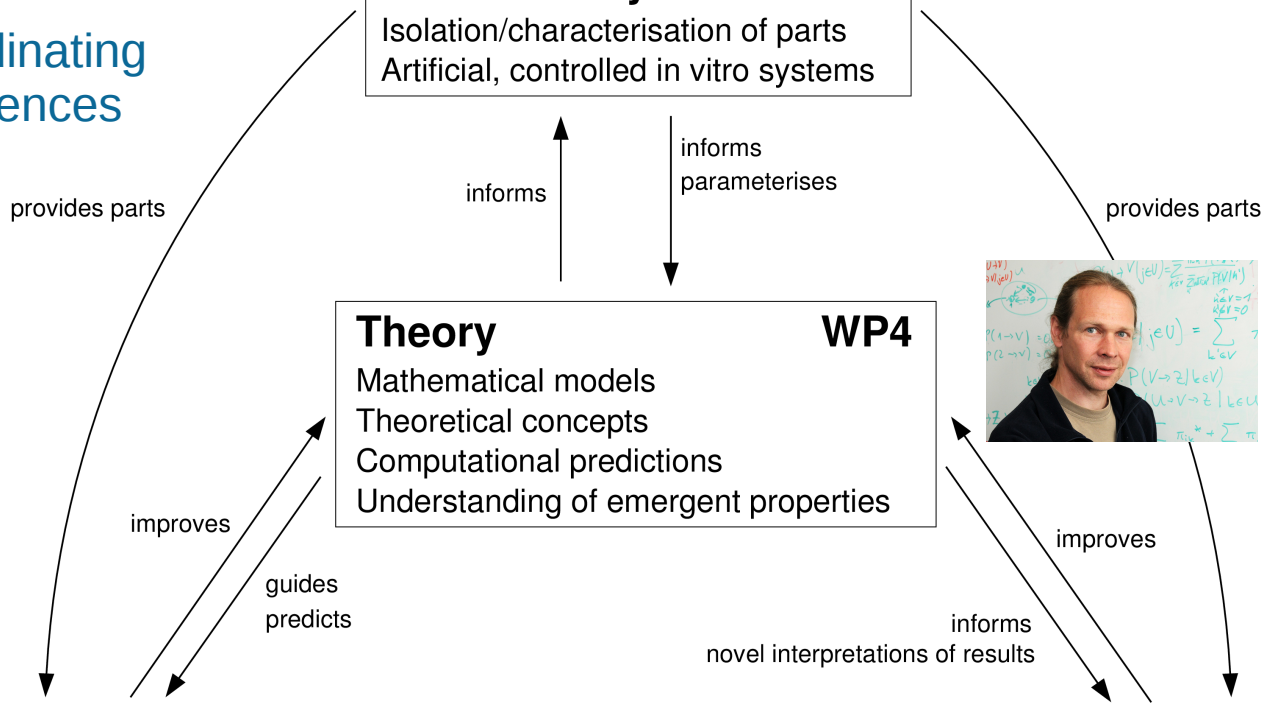

Starch metabolism: ingredients

A unique molecule

Ordered part

As a 2D tree

Double helices

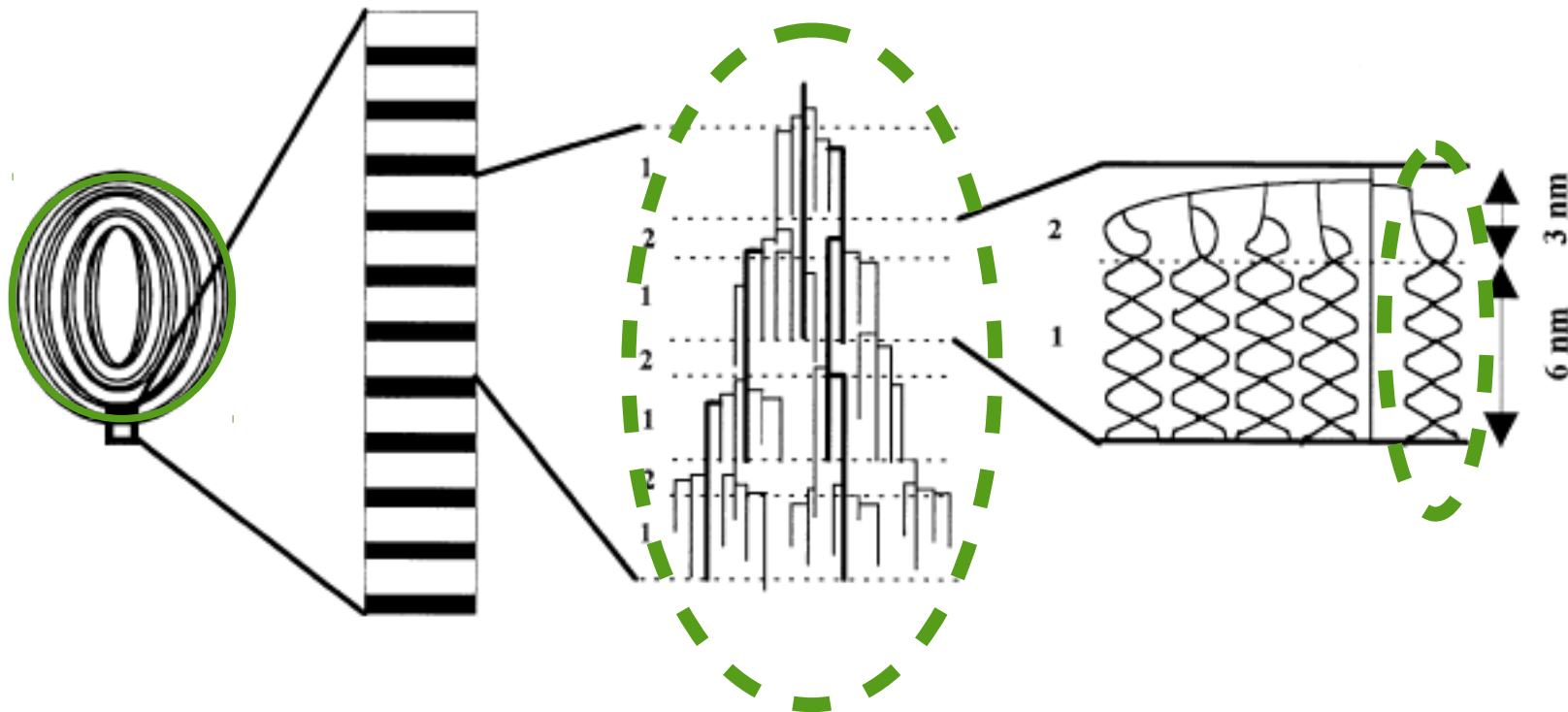

Genealogy of the tree (mother-daughter connections)

Starch metabolism: ingredients

The main reactions

Elongation α -1,4 \longrightarrow α -1,4 (+1)

Branching (cut & re-branch) α -1,4 \longrightarrow α -1,6

Debranching α -1,6 \longrightarrow \emptyset

Double helix formation

We need detailed kinetic descriptions of all involved enzymatic and biophysical processes!

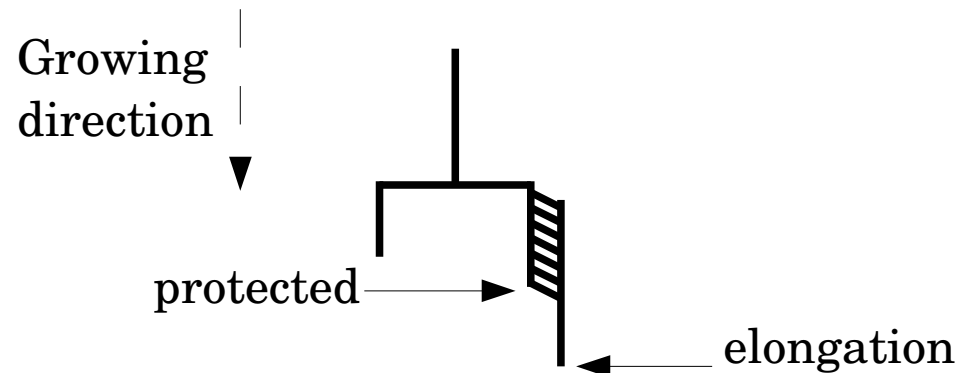

Starch metabolism bottom-up

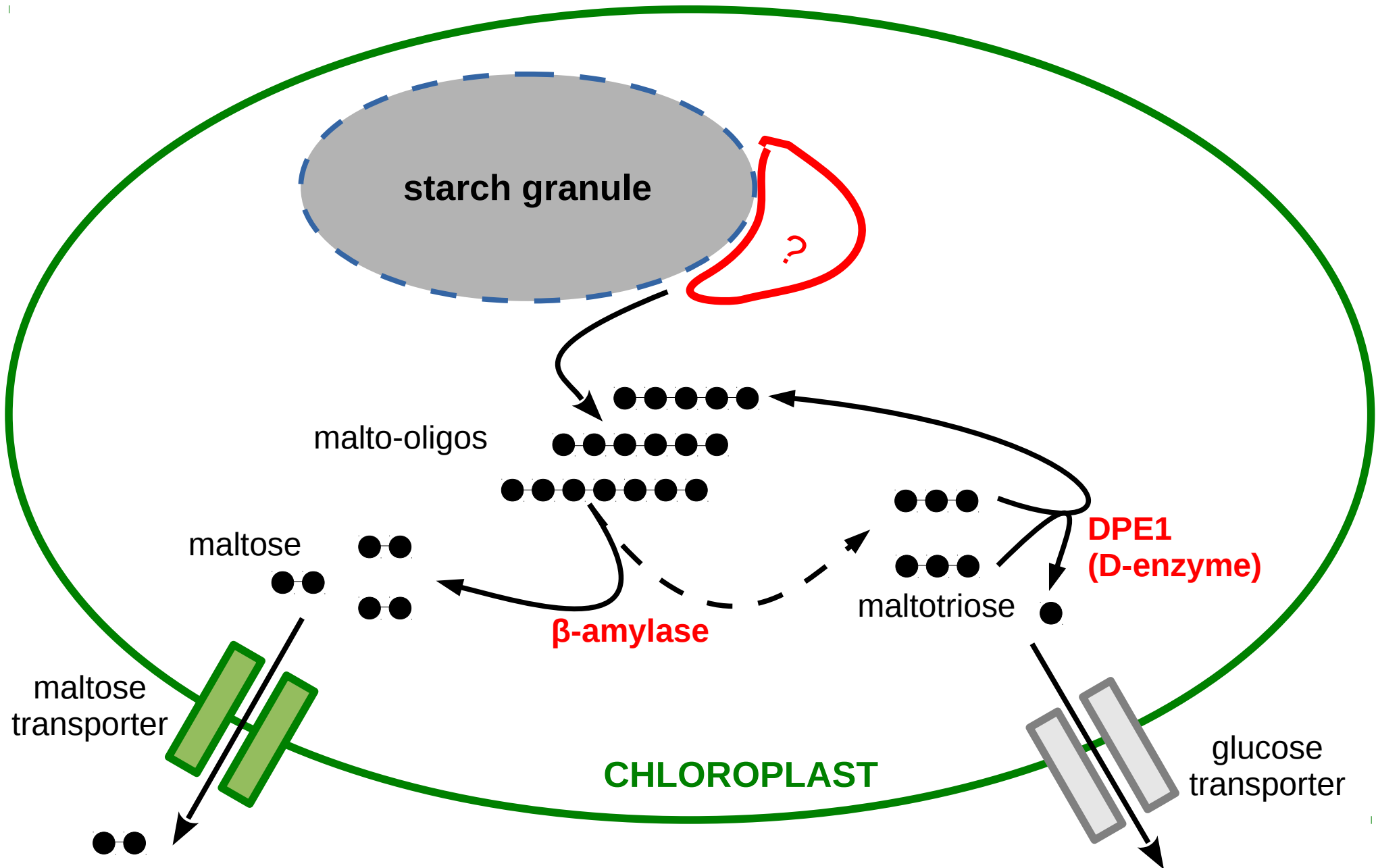

Disproportionating enzymes (D-enzymes)

DPE1

EC: 2.4.1.25

catalyses $2 \text{ maltotriose} \leftrightarrow \text{maltopentaose} + \text{glucose}$

$G3 + G3 \leftrightarrow G5 + G1$

but not only!

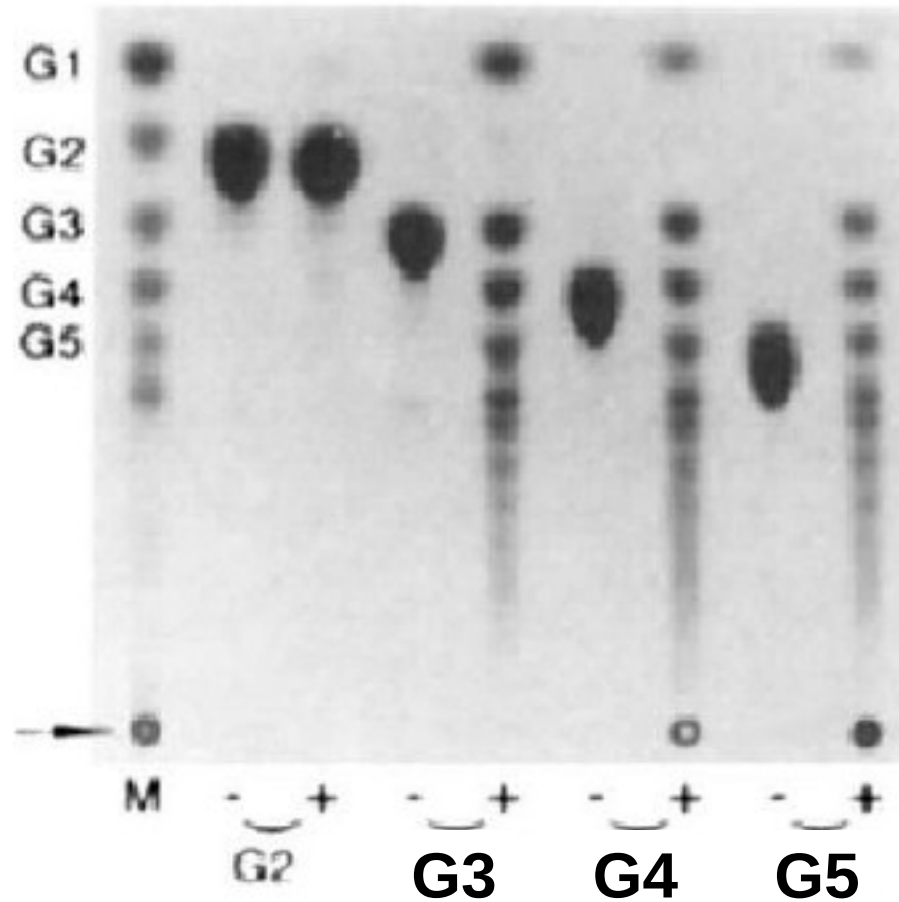

DPE1 produces a set of glucans of different length in *in vitro* assays.

(Takaha et al., JBC 1993)

Disproportionating enzymes (D-enzymes)

DPE1

EC: 2.4.1.25

catalyses $2 \text{ maltotriose} \rightleftharpoons \text{maltopentaose} + \text{glucose}$
 $G3 + G3 \rightleftharpoons G5 + G1$

but not only!

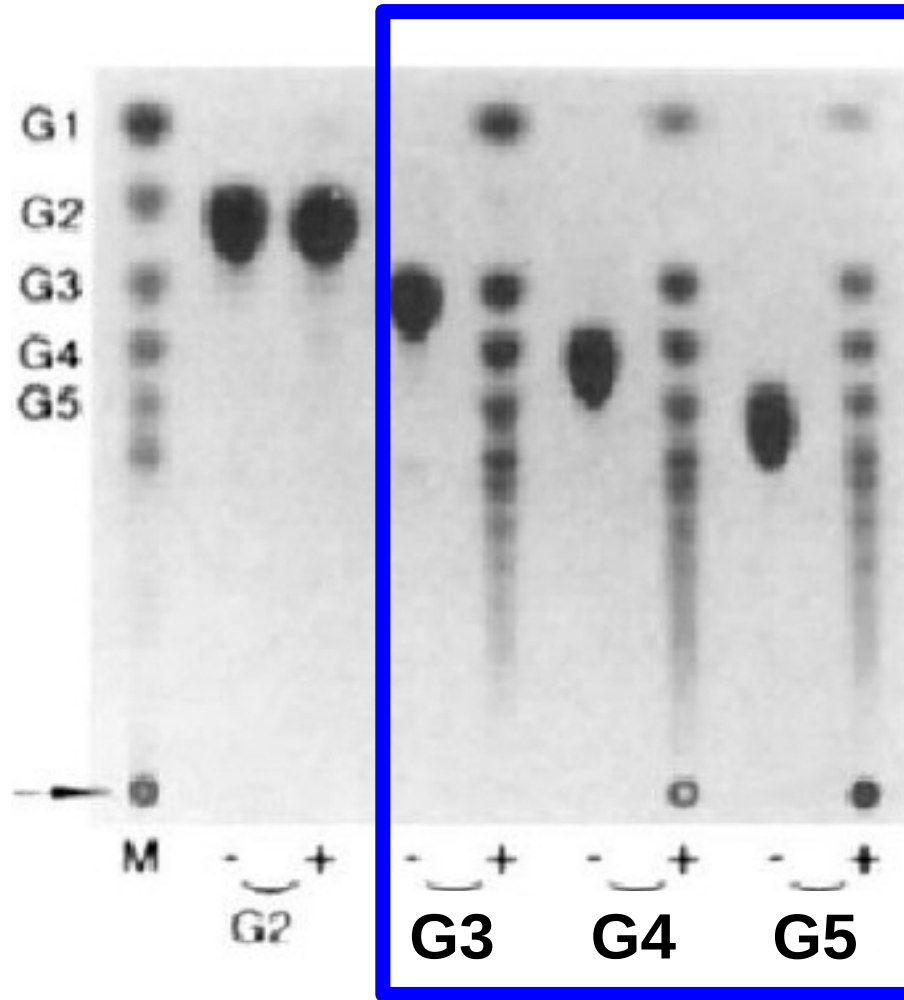

DPE1 produces a set of glucans of different length in *in vitro* assays.

Equilibrium distribution depends on initial conditions!

(Takaha et al., JBC 1993)

$K_{eq} ???$

Positional Isomers

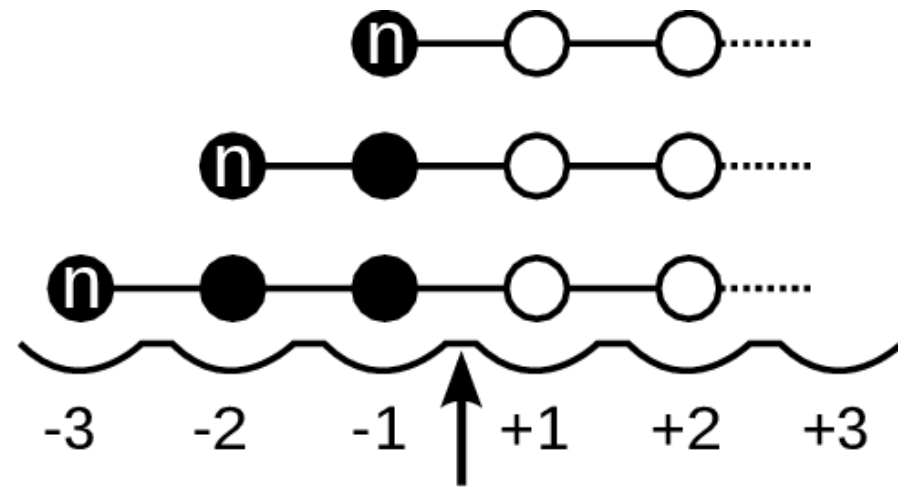
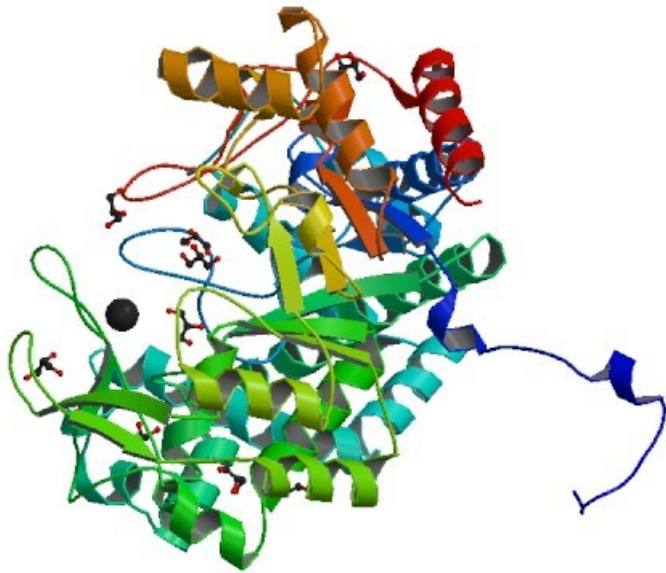

D-Enzyme Subsite

Different binding modes of the donor substrate exists

⇒ 1, 2 or 3 glucose residues can be transferred

⇒ The general reaction equation is $G_n + G_m \rightleftharpoons G_{n-q} + G_{m+q}$ with $q=1,2,3$

Positional Isomers

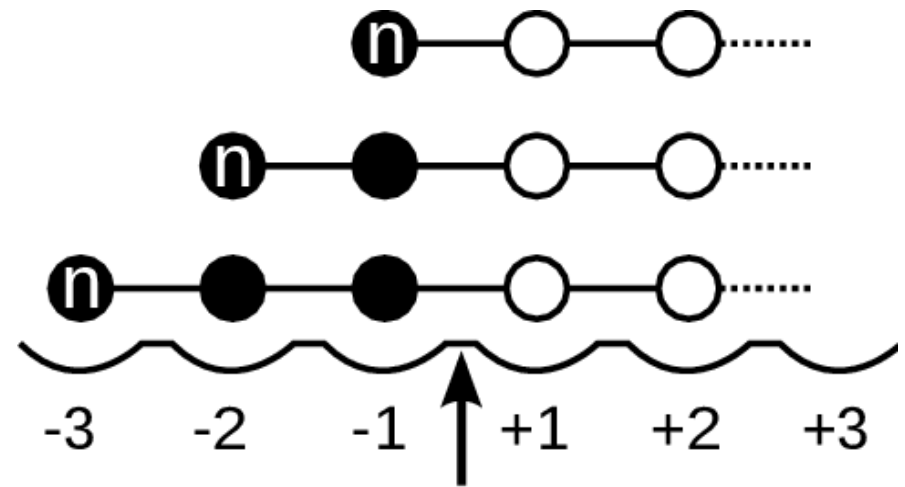
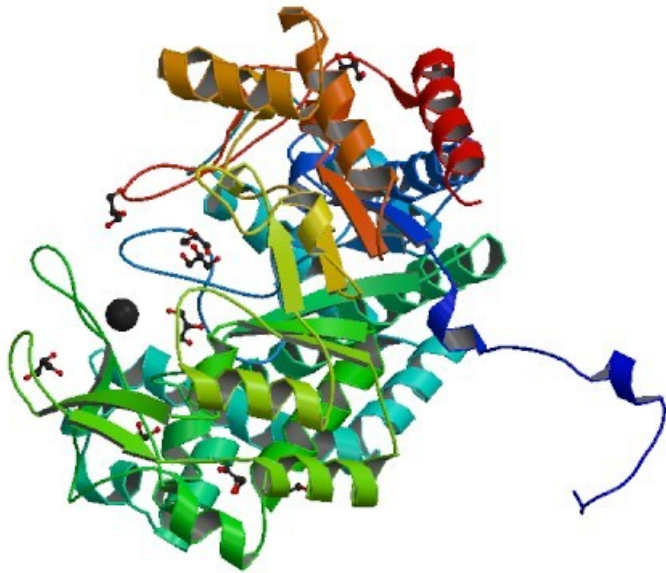

D-Enzyme Subsite

Different binding modes of the donor substrate exists

⇒ 1, 2 or 3 glucose residues can be transferred

⇒ The general reaction equation is $G_n + G_m \rightleftharpoons G_{n-q} + G_{m+q}$ with $q=1,2,3$

For such a reaction, what is the meaning of K_M ???

Disproportionating enzymes (D-enzymes)

DPE1

EC: 2.4.1.25

Disproportionating Enzyme
randomises DPs

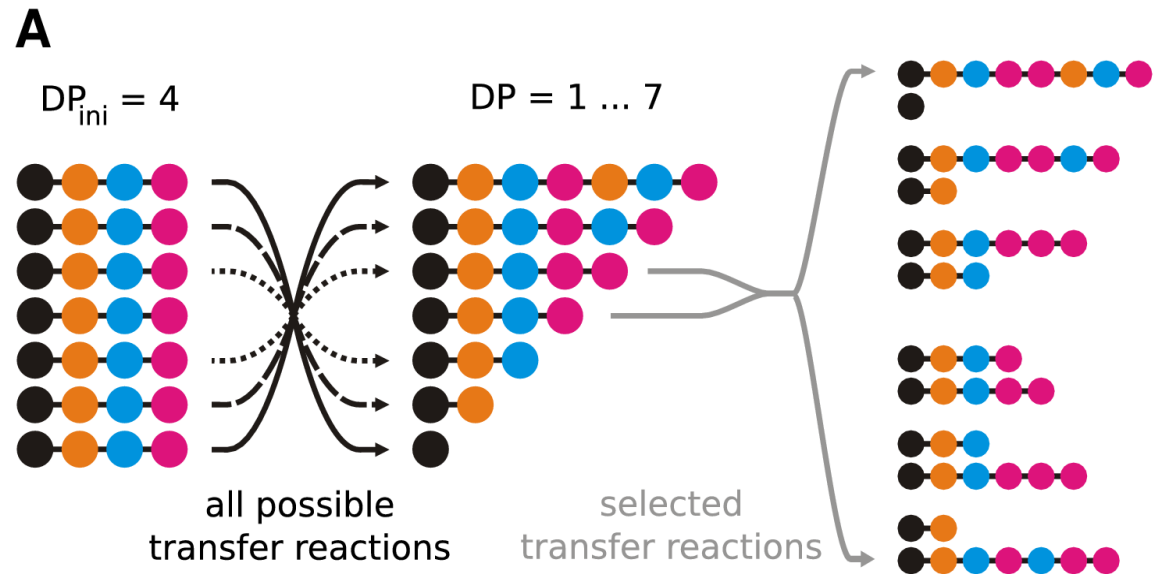

transfers glucosyl residues from one glucan to another: $G_n + G_m \rightleftharpoons G_{n-q} + G_{m+q}$

reaction must proceed towards a smaller Gibbs free energy : $\Delta G = \Delta H - T \Delta S < 0$

energy neutral (enthalpy of α -1,4-bond hydrolysis independent on position): $\Delta H = 0$
(Goldberg et al, 1992)



DPE1 maximises the entropy of the polydisperse reactant mixture

Polydisperse mixtures as statistical ensembles

x_i : molar fraction of glucans with length i
corresponds to occupation number of state i

The distribution $\{x_i\}$ fully characterises the polydisperse reactant mixture

The entropy of the statistical ensemble is $S = -\sum x_k \ln x_k$

Equilibrium is determined by maximal entropy:

$$S = -\sum x_k \ln x_k \rightarrow \max!$$

**Maximum entropy principle
under constraint that #bonds
and #molecules is conserved!**

conservation of #molecules: $\sum x_k = 1$

conservation of #bonds: $\sum k \cdot x_k = b$

**determined by
initially applied
mixture of
maltodextrins**



Entropic approach

Solution using Lagrangian multipliers: Necessary conditions are given by

$$\frac{\partial L}{\partial x_k} = 0 \quad \text{with} \quad L(x_k; \alpha, \beta) = \sum_k x_k \ln(x_k) + \alpha \left(\sum_k x_k - 1 \right) + \beta \left(\sum_k k \cdot x_k - b \right)$$

$$\Leftrightarrow \ln(x_k) + 1 + \alpha + k \beta = 0 \quad \text{for all } k$$

Entropic approach

Solution using Lagrangian multipliers: Necessary conditions are given by

$$\frac{\partial L}{\partial x_k} = 0 \quad \text{with} \quad L(x_k; \alpha, \beta) = \sum_k x_k \ln(x_k) + \alpha \left(\sum_k x_k - 1 \right) + \beta \left(\sum_k k \cdot x_k - b \right)$$

$$\Leftrightarrow \ln(x_k) + 1 + \alpha + k\beta = 0 \quad \text{for all } k$$

$$\Rightarrow \boxed{x_k = \frac{1}{Z} e^{-k\beta}} \quad \text{with} \quad Z = \sum_k e^{-k\beta}$$

Entropic approach

Solution using Lagrangian multipliers: Necessary conditions are given by

$$\frac{\partial L}{\partial x_k} = 0 \quad \text{with} \quad L(x_k; \alpha, \beta) = \sum_k x_k \ln(x_k) + \alpha \left(\sum_k x_k - 1 \right) + \beta \left(\sum_k k \cdot x_k - b \right)$$

$$\Leftrightarrow \ln(x_k) + 1 + \alpha + k\beta = 0 \quad \text{for all } k$$

$$\Rightarrow \boxed{x_k = \frac{1}{Z} e^{-k\beta}} \quad \text{with} \quad Z = \sum_k e^{-k\beta}$$

Analogy to statistical physics! $\left(\text{There, } \beta = \frac{1}{k_B \cdot T} \right)$

Entropic approach

Solution using Lagrangian multipliers: Necessary conditions are given by

$$\frac{\partial L}{\partial x_k} = 0 \quad \text{with} \quad L(x_k; \alpha, \beta) = \sum_k x_k \ln(x_k) + \alpha \left(\sum_k x_k - 1 \right) + \beta \left(\sum_k k \cdot x_k - b \right)$$

$$\Leftrightarrow \ln(x_k) + 1 + \alpha + k\beta = 0 \quad \text{for all } k$$

$$\Rightarrow \boxed{x_k = \frac{1}{Z} e^{-k\beta}} \quad \text{with} \quad Z = \sum_k e^{-k\beta}$$

Analogy to statistical physics! $\left(\text{There, } \beta = \frac{1}{k_B \cdot T} \right)$

$$\text{Calculation of } \beta: \quad -\frac{1}{Z} \frac{\partial Z}{\partial \beta} = b \Leftrightarrow \beta = \ln \frac{b+1}{b}$$

Entropic approach

Solution using Lagrangian multipliers: Necessary conditions are given by

$$\frac{\partial L}{\partial x_k} = 0 \quad \text{with} \quad L(x_k; \alpha, \beta) = \sum_k x_k \ln(x_k) + \alpha \left(\sum_k x_k - 1 \right) + \beta \left(\sum_k k \cdot x_k - b \right)$$

$$\Leftrightarrow \ln(x_k) + 1 + \alpha + k\beta = 0 \quad \text{for all } k$$

$$\Rightarrow \boxed{x_k = \frac{1}{Z} e^{-k\beta}} \quad \text{with} \quad Z = \sum_k e^{-k\beta}$$

Analogy to statistical physics! $\left(\text{There, } \beta = \frac{1}{k_B \cdot T} \right)$

$$\text{Calculation of } \beta: \quad -\frac{1}{Z} \frac{\partial Z}{\partial \beta} = b \Leftrightarrow \beta = \ln \frac{b+1}{b}$$

$$\text{Maximal entropy in equilibrium: } S_{max} = (b+1) \ln(b+1) - b \ln b$$

Entropic approach

$$S = - \sum x_k \ln x_k \rightarrow \max!$$

conservation of #molecules: $\sum x_k = 1$

conservation of #bonds: $\sum k \cdot x_k = DP_{ini} - 1$

implies

$$x_i = \frac{1}{Z} e^{-\beta E_i}, \quad \beta = \ln \frac{DP_{ini}}{DP_{ini} - 1}$$

predicts

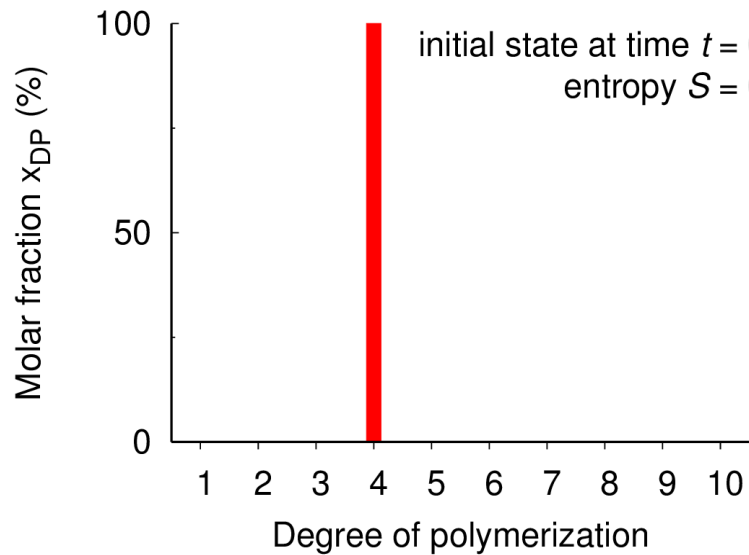

DPE1 action

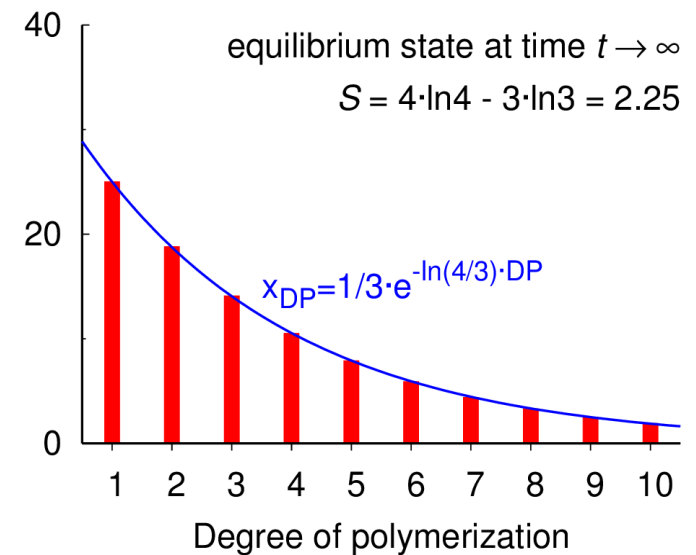
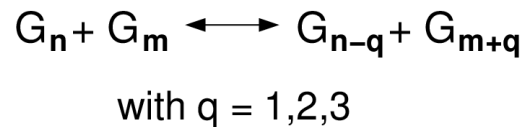

An instance of the
2nd law of TD!

DPE1 is entropy driven

Experiments with Martin Steup, University of Potsdam

method: capillary electrophoresis

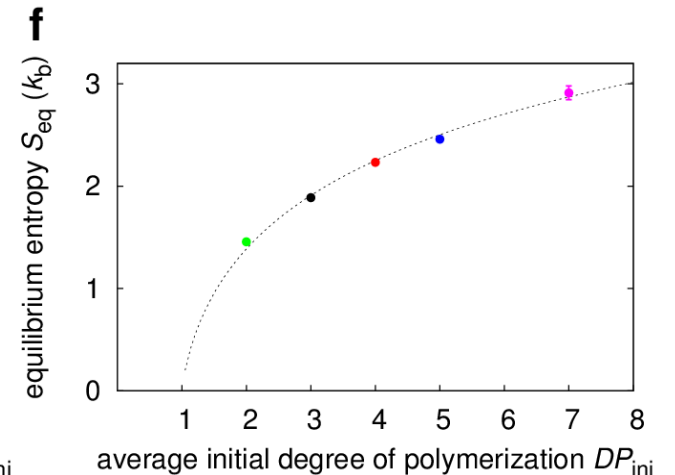
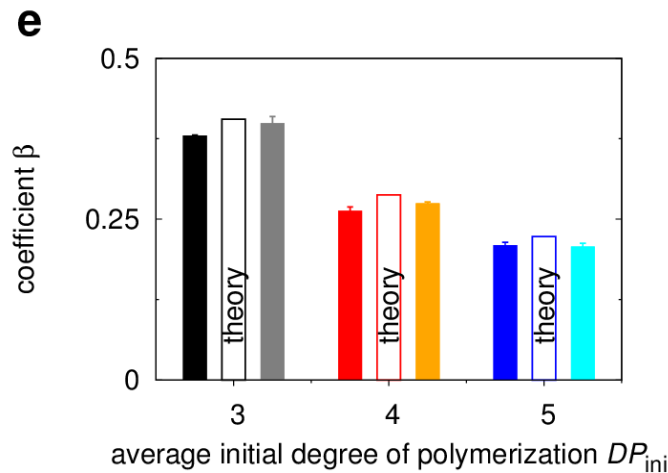
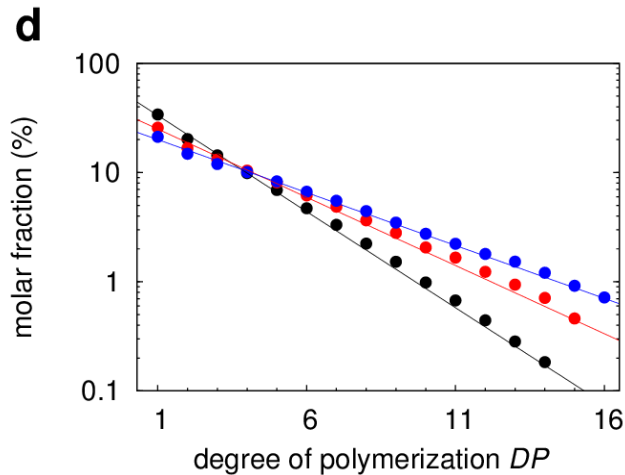
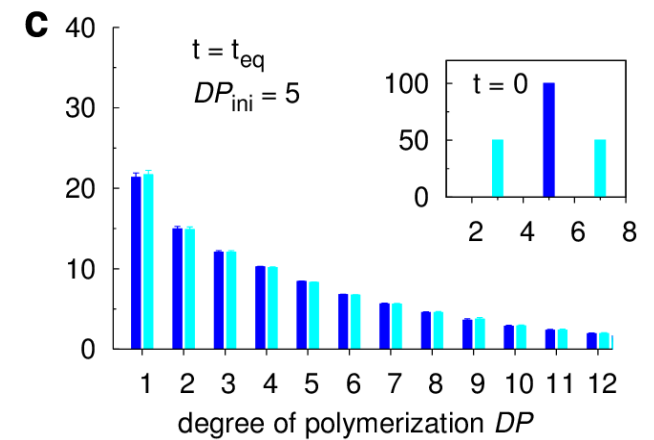
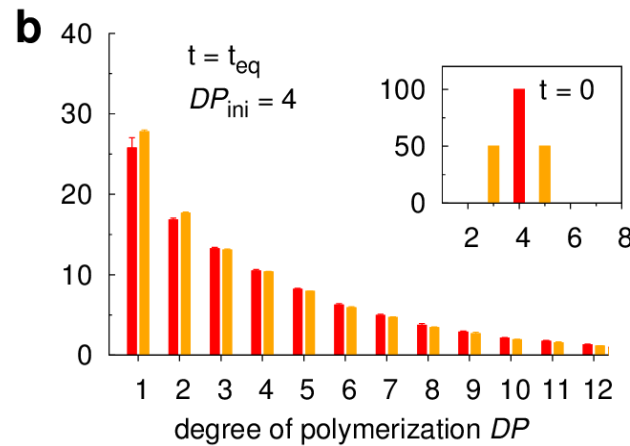
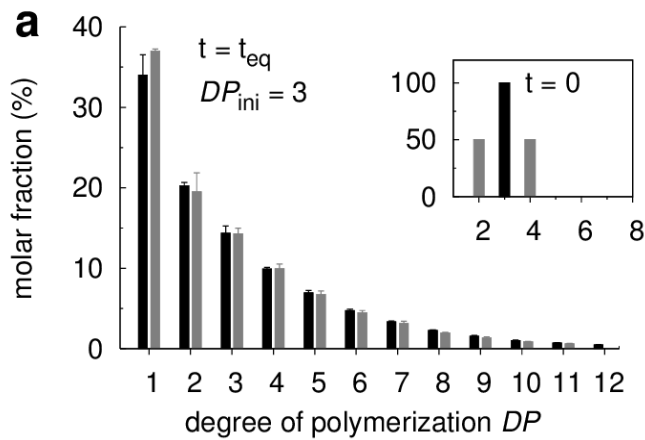

β is a generalisation of the equilibrium constant for polydisperse mixtures

(Kartal et al, 2011, Mol Syst Biol)

The dynamics of DPE1

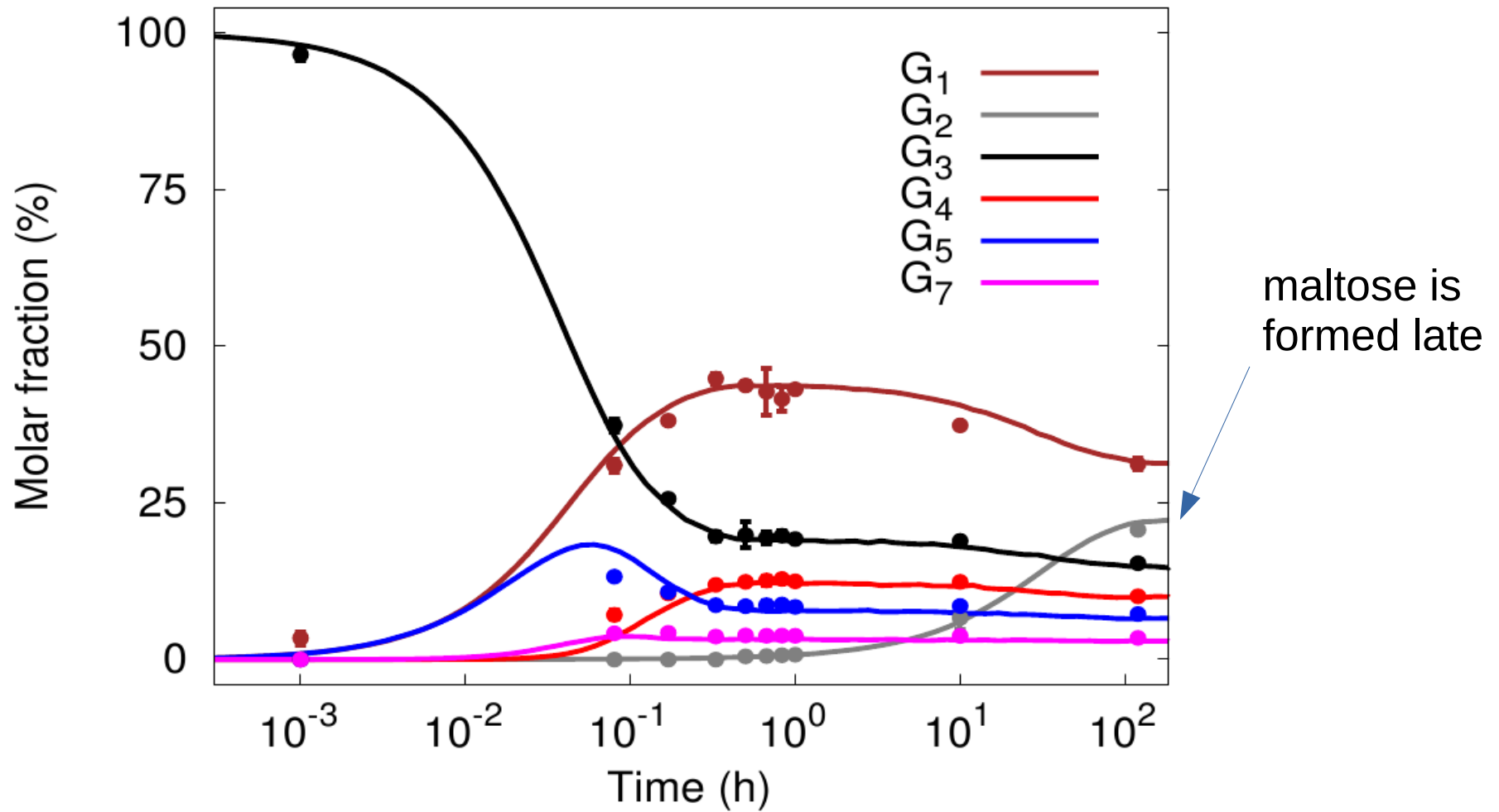

Two time scales!

The dynamics of DPE1

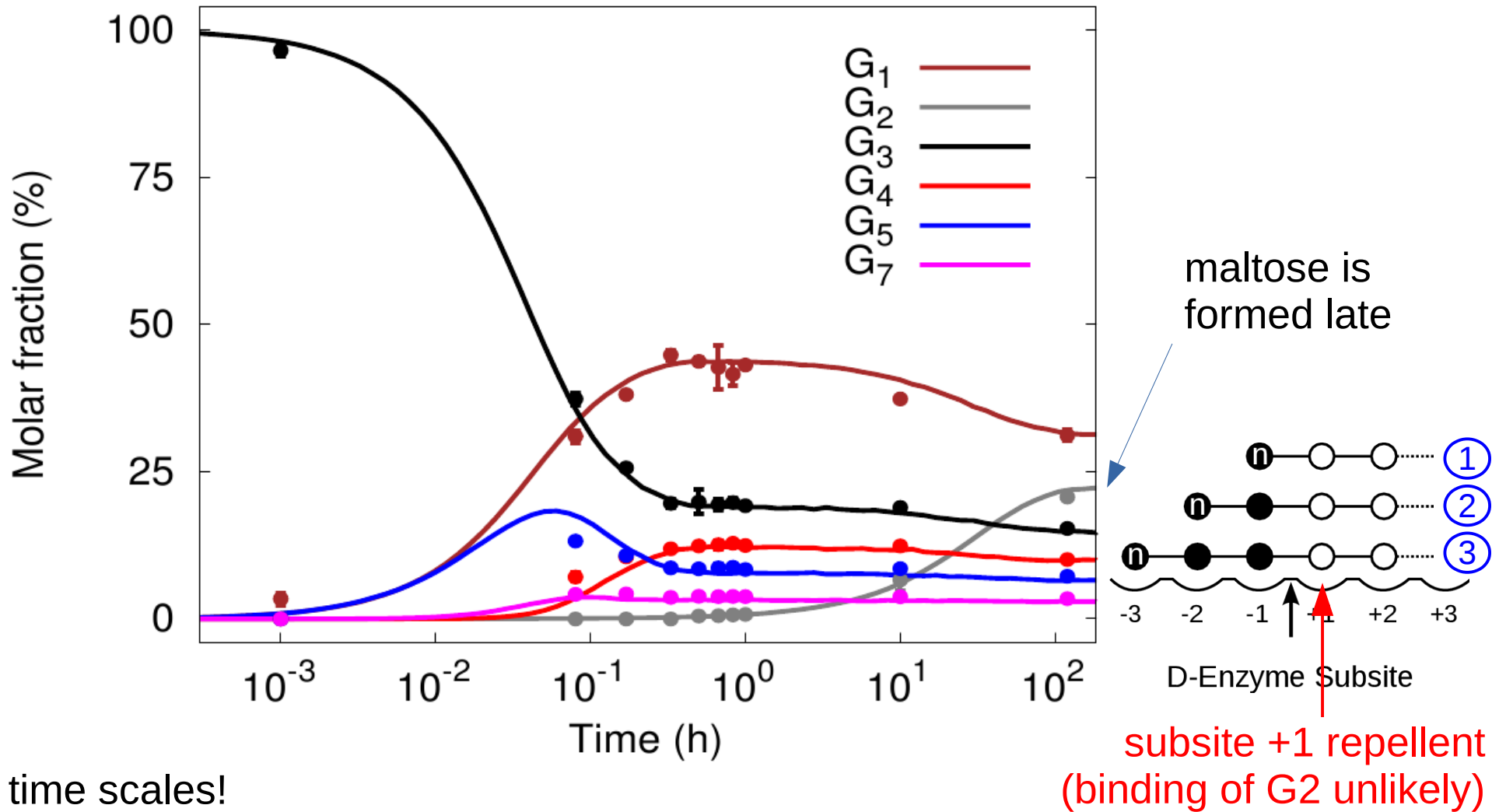

Two time scales!

The simulations used 3 parameters:

- maximal turnover
- affinity for positional isomer 1
- affinities for positional isomers 2 and 3

ratio 1:800

Affinities: K_M

This system allows to follow the entropy *experimentally*!

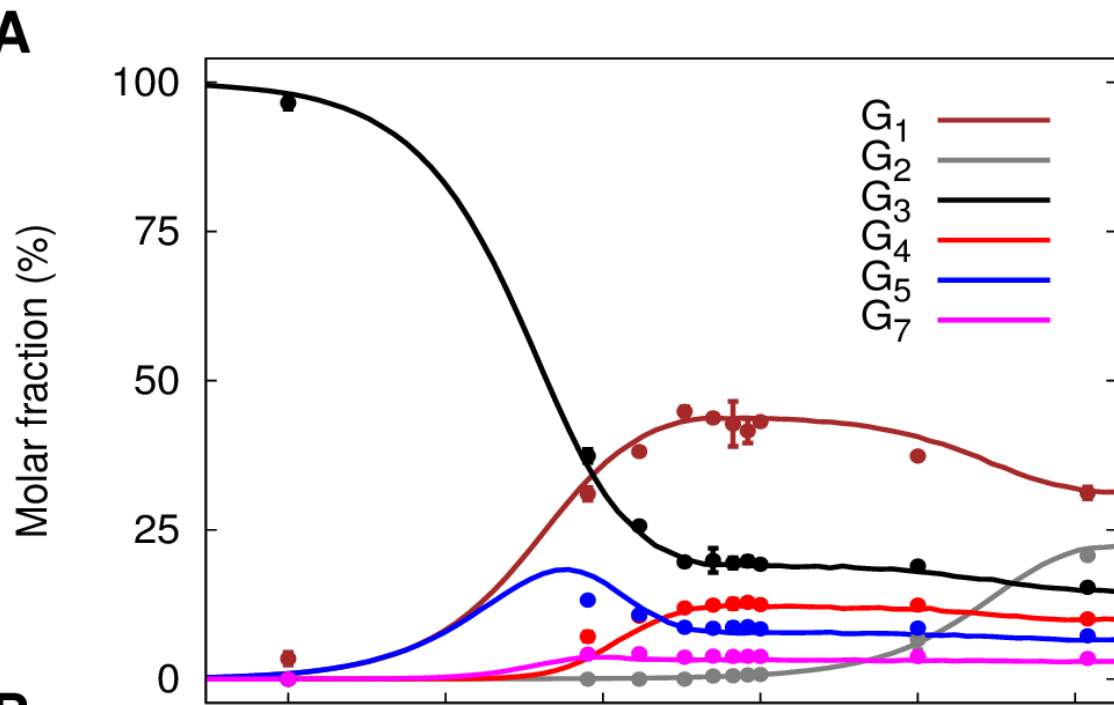

“true” equilibrium
(calculated as previously)

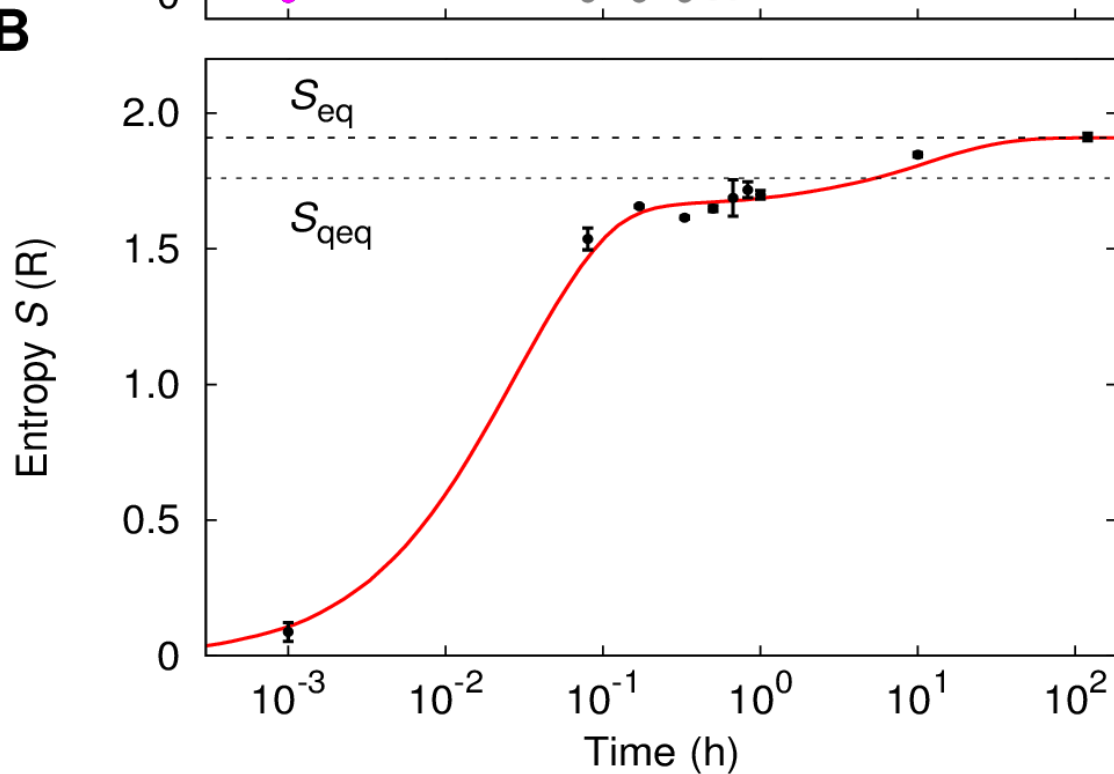

“quasi” equilibrium
(calculated with the same approach but omitting maltose from the statistical ensemble)

This system allows to follow the entropy *experimentally!*

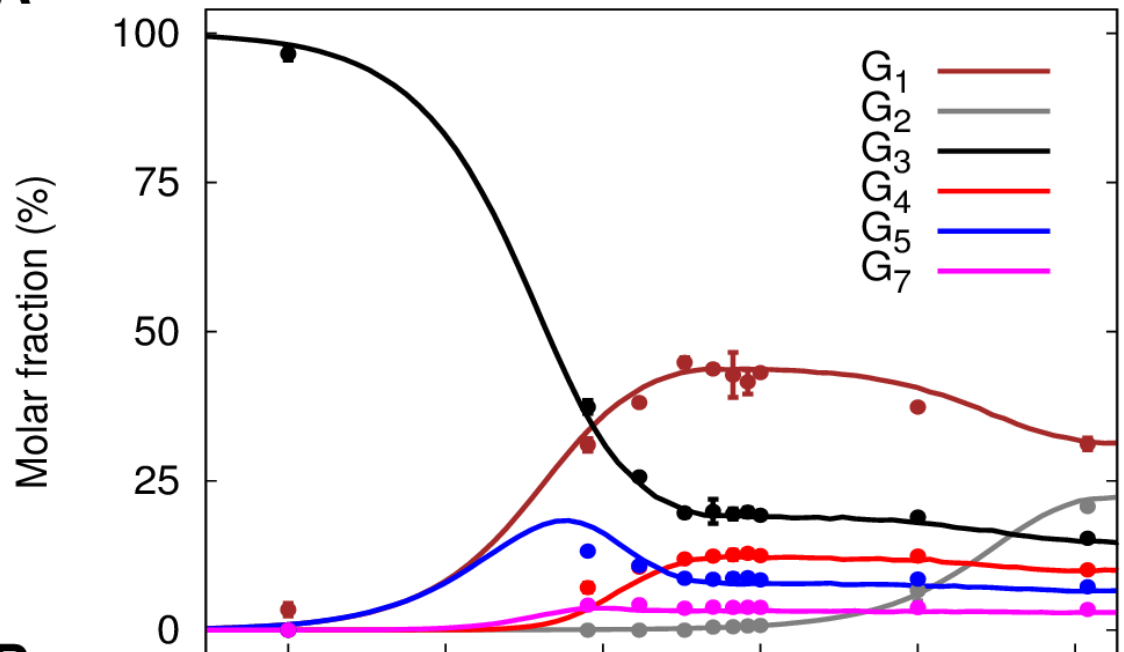

“true” equilibrium
(calculated as previously)

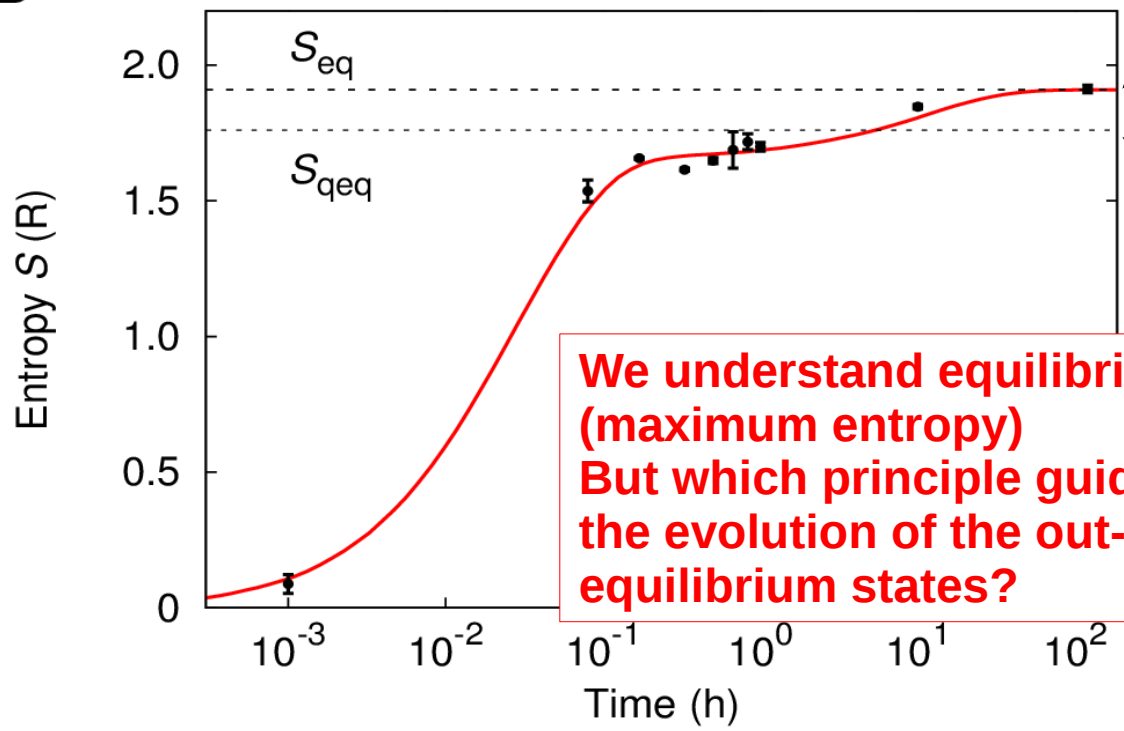

“quasi” equilibrium
(calculated with the same approach but omitting maltose from the statistical ensemble)

**We understand equilibrium (maximum entropy)
But which principle guides the evolution of the out-of-equilibrium states?**

Theory is also confirmed by DPE2

DPE2 vs DPE1

- transfers single glucosyl residues
- G2 only used as donor
- G3 only used as acceptor

Generic reaction catalysed:

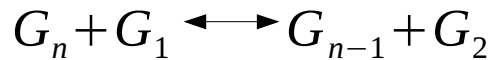

$$\Rightarrow x_i = \frac{1}{Z} e^{-\beta E_i} \text{ for } i \geq 3 \text{ where } \beta \text{ fulfils } b - 2(1-m) = m \cdot \frac{e^{-\beta}}{1+e^{-\beta}} + (1-m) \cdot \frac{e^{-\beta}}{1-e^{-\beta}}$$

Entropic principle:

$$S = - \sum_k x_k \ln x_k \rightarrow \max$$

with one additional side constraint

$$x_1 + x_2 = m = \text{const.} \quad \left(\text{and } \sum x_k = 1; \sum k \cdot x_k = b \right)$$

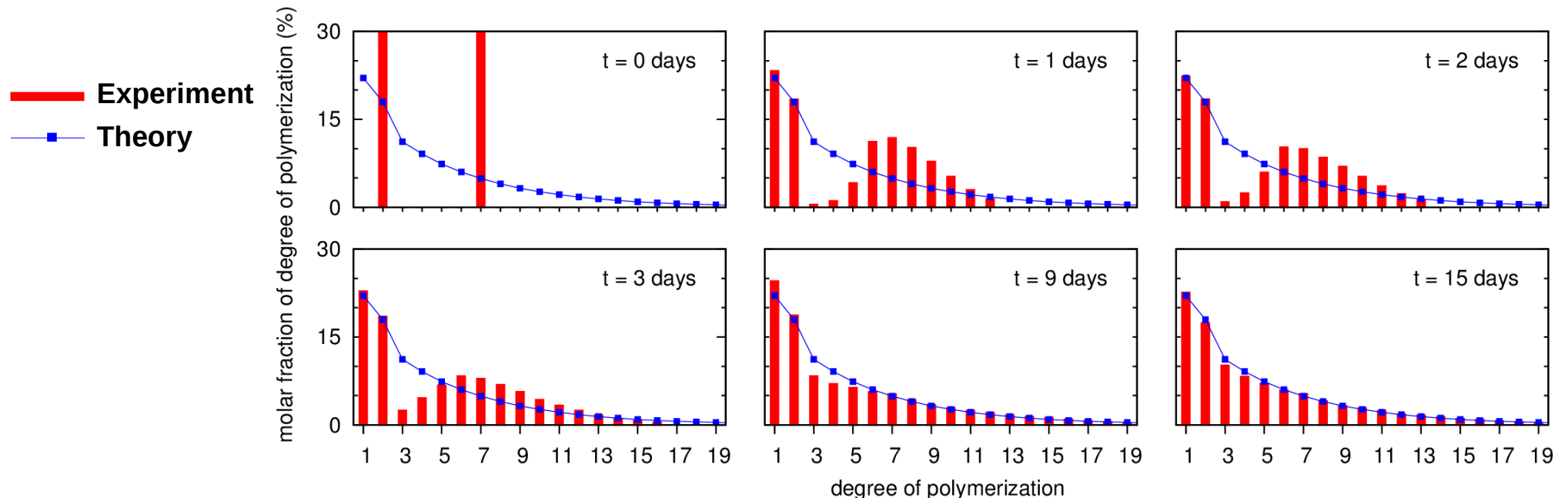

Theory is also confirmed by DPE2

DPE2 vs DPE1

- transfers single glucosyl residues
- G2 only used as donor
- G3 only used as acceptor

Generic reaction catalysed:

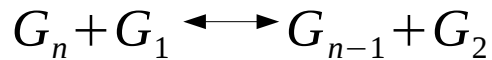

$$\Rightarrow x_i = \frac{1}{Z} e^{-\beta E_i} \text{ for } i \geq 3 \text{ where } \beta \text{ fulfils } b - 2(1-m) = m \cdot \frac{e^{-\beta}}{1+e^{-\beta}} + (1-m) \cdot \frac{e^{-\beta}}{1-e^{-\beta}}$$

Entropic principle:

$$S = - \sum_k x_k \ln x_k \rightarrow \max$$

with one additional side constraint

$$x_1 + x_2 = m = \text{const.} \quad \left(\text{and } \sum x_k = 1; \sum k \cdot x_k = b \right)$$

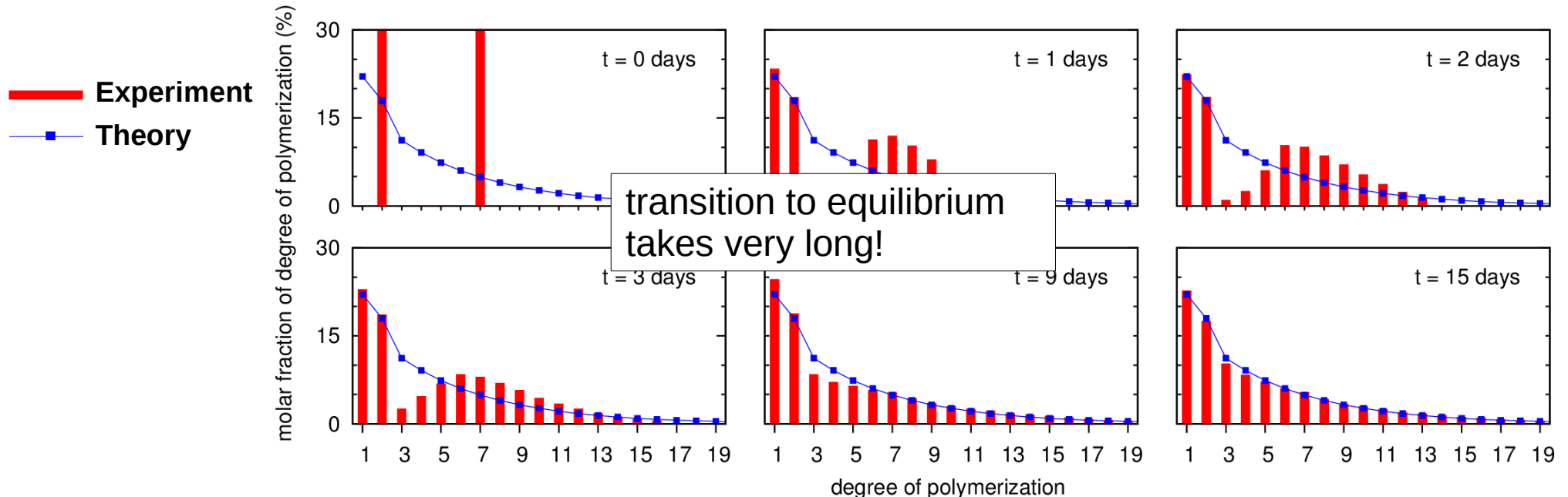

Generalisation to non-zero enthalpy changes

Phosphorylase (cPho):

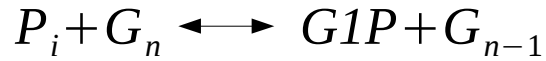

$\Delta H \neq 0!$

phosphoester bond

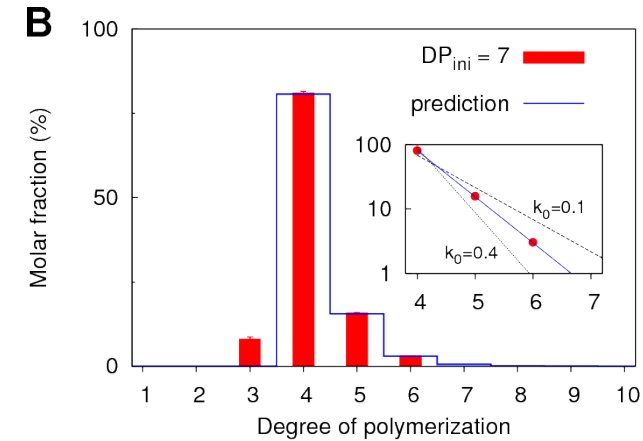
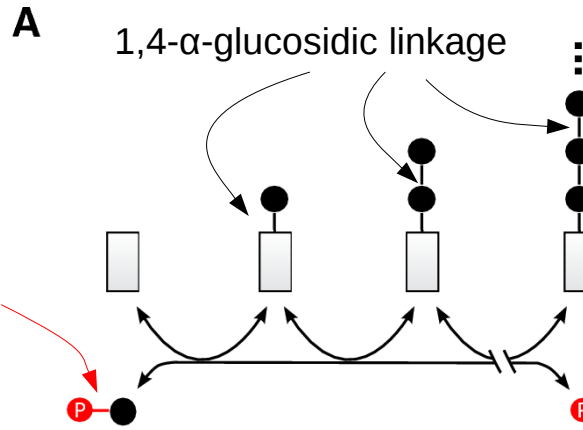

Generalisation by including energetic and entropic contributions:

$$G = G^f - T \cdot S_{mix} \rightarrow \min!$$

Gibbs energy of formation

mixing entropy:

$$S_{mix} = -R \sum x_k \ln x_k$$

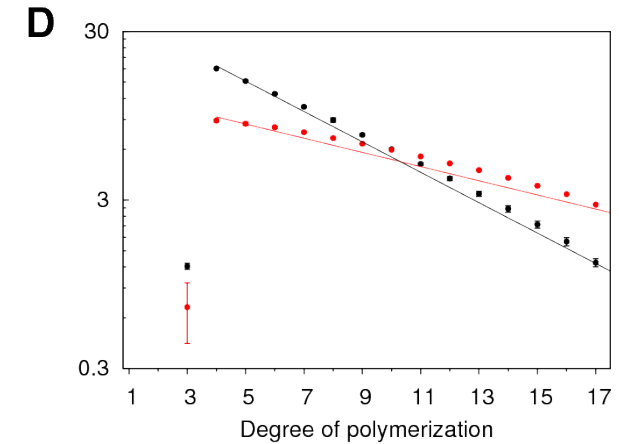
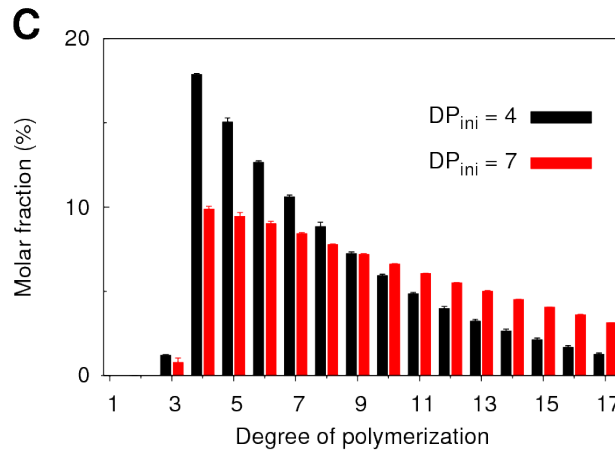

Prediction: Similar pattern as for DPE2

Experimentally confirmed.

An entropy-driven buffer

Two entropic enzymes, cPho and DPE2, integrate input from many chloroplasts

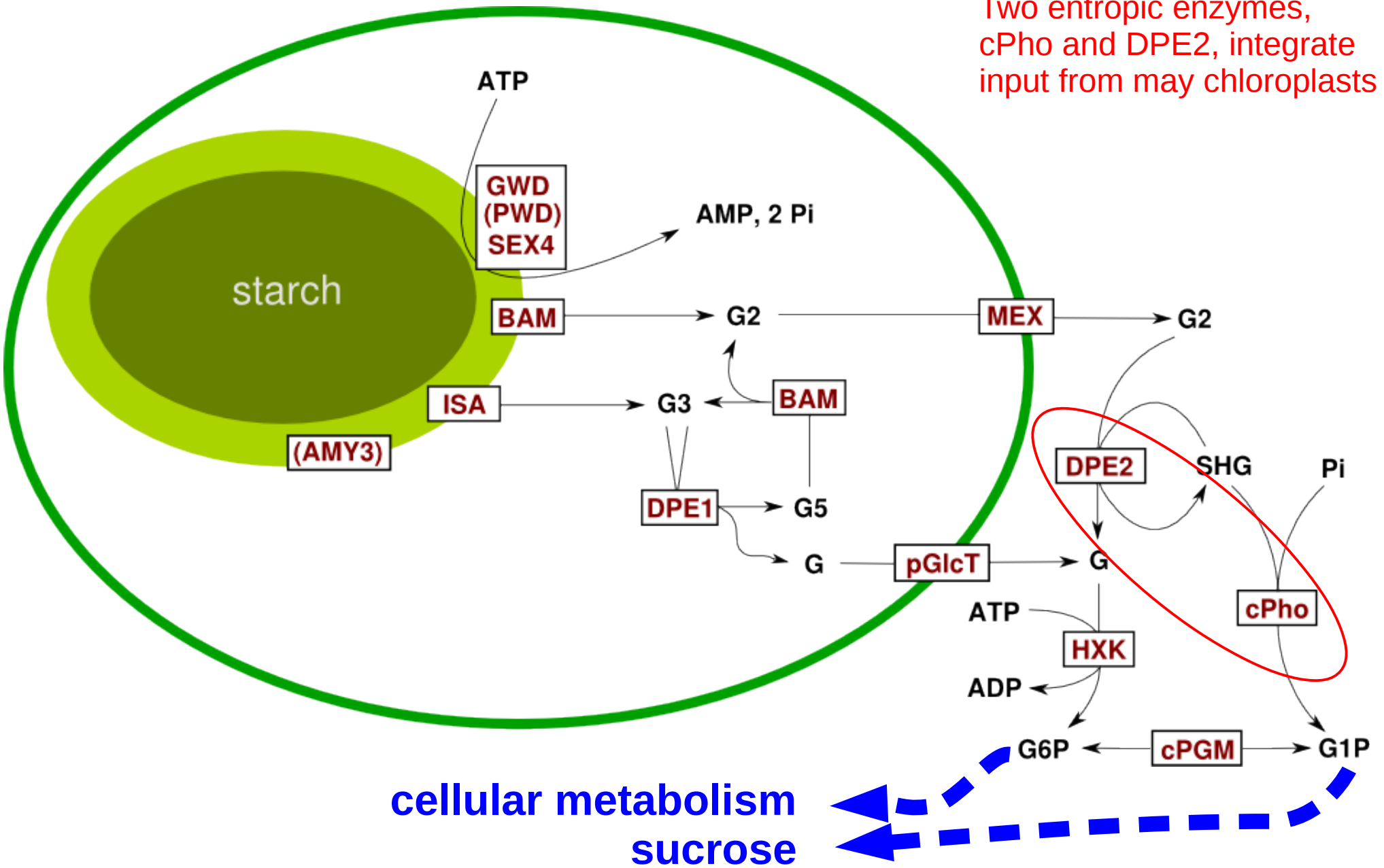

cellular metabolism
sucrose

What is the role of the SHG pool?

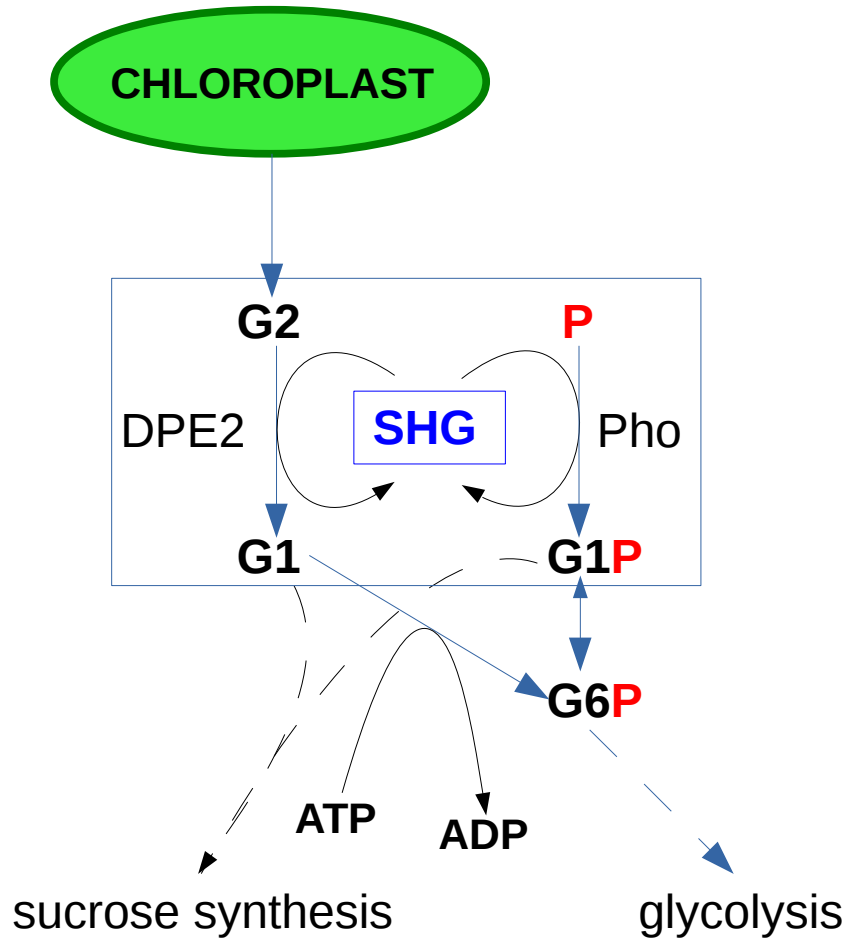

Two 'entropic' enzymes mediate the turnover of a polydisperse pool

What is the advantage over other hypothetical systems?

What is the role of the SHG pool?

Comparison with two alternatives

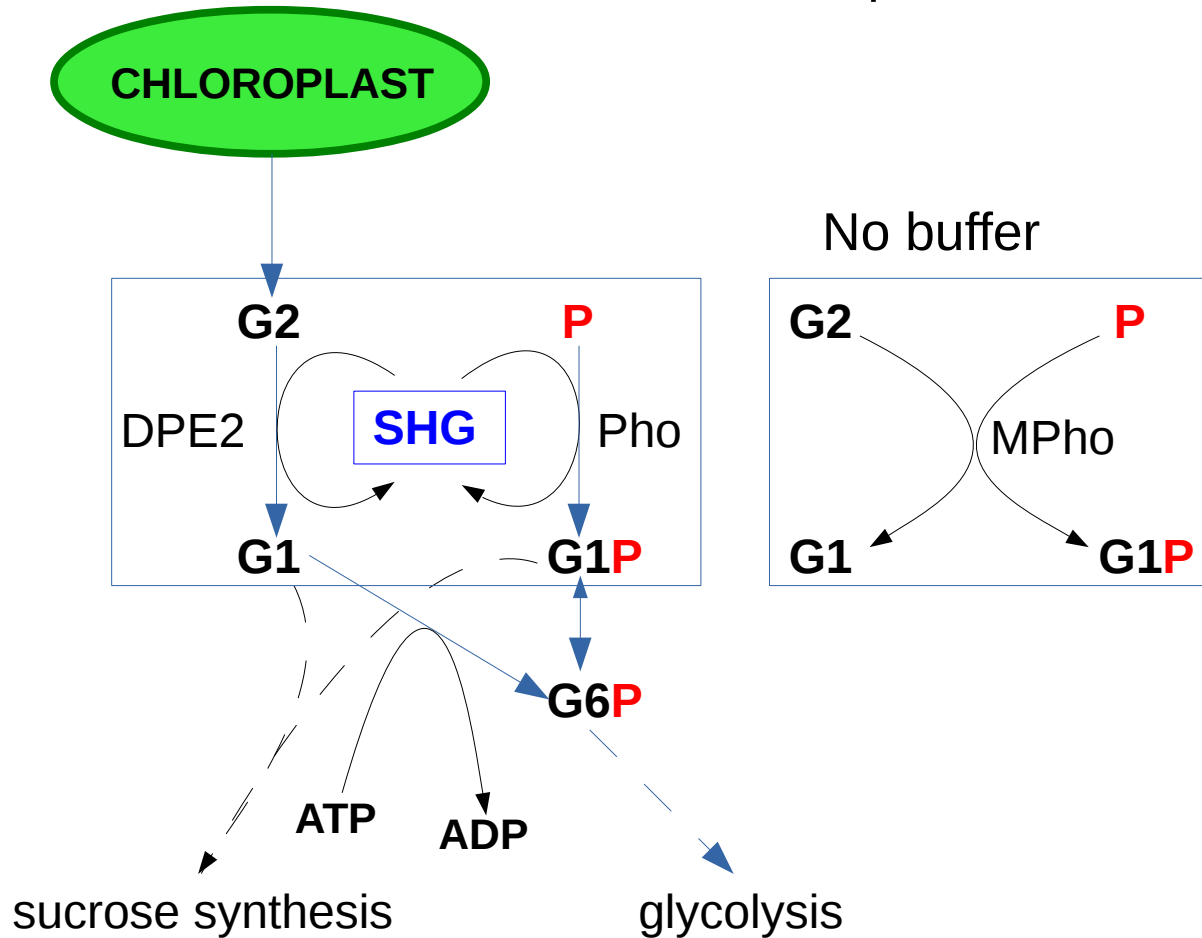

Polydisperse SHG pools increases robustness *in vivo*

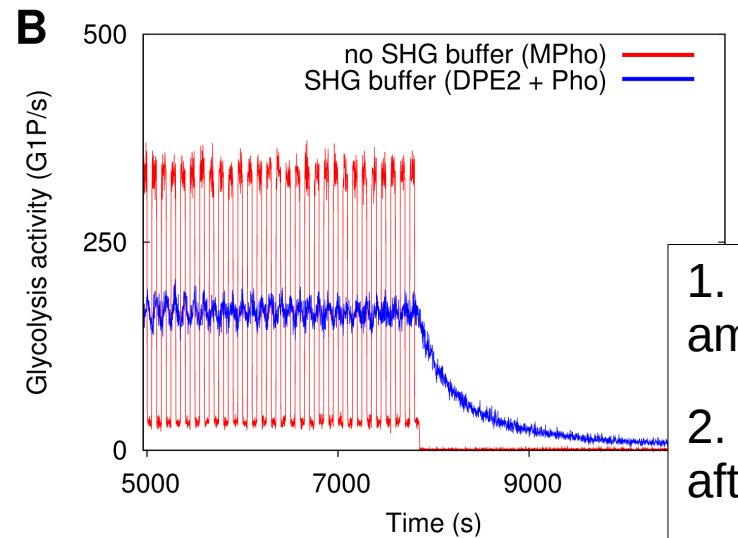
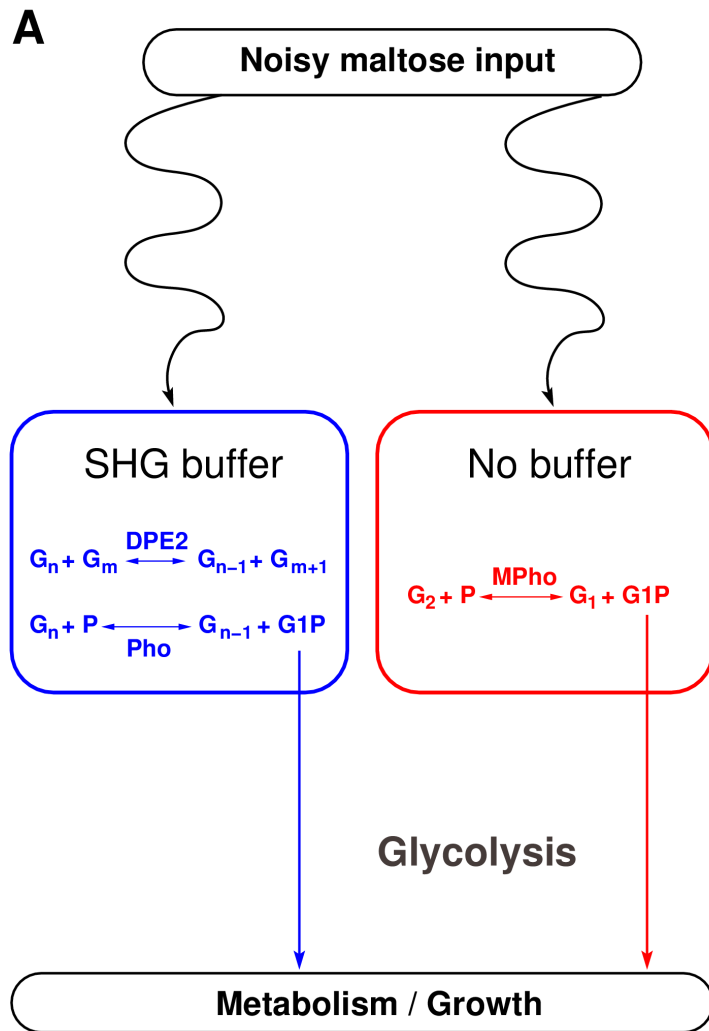

1. Attenuation of fluctuation amplitude (low-pass filter)
2. Transient support of activity after drop of maltose influx
3. Buffering large variations in influx to provide robust output activity

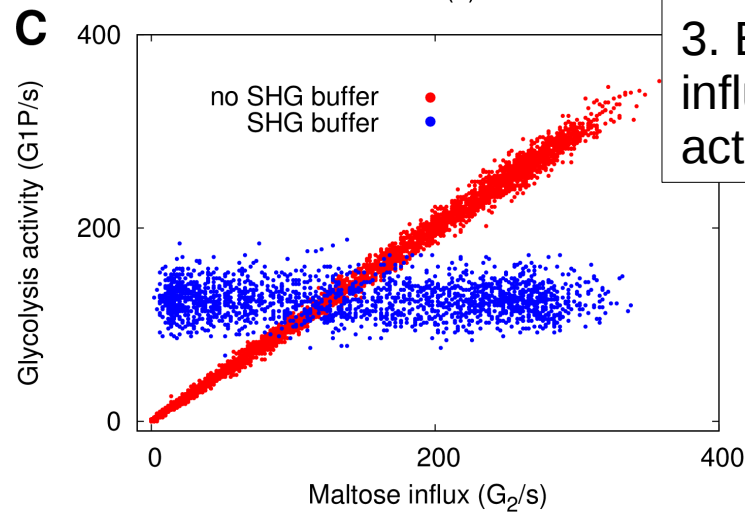

Challenge: explain observations with bottom-up approach

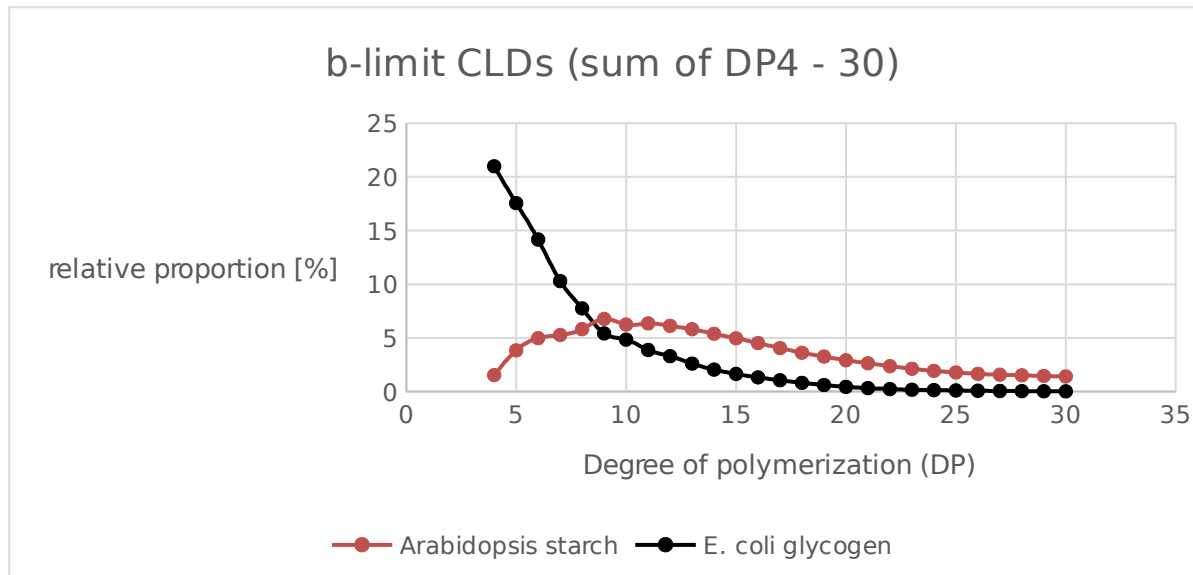
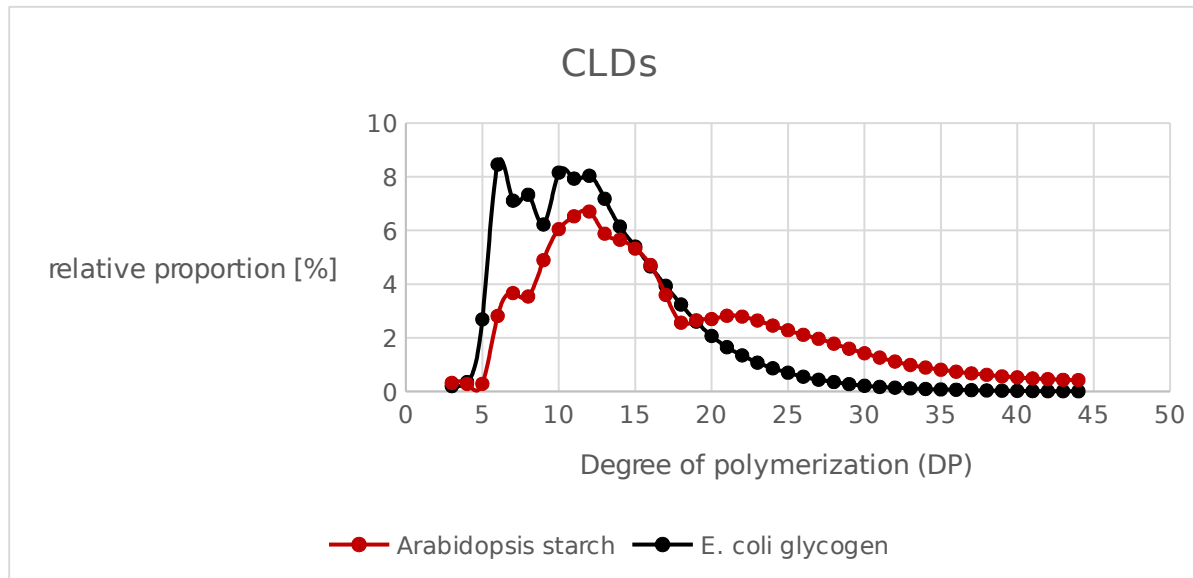

Goal: reproduce emergent macroscopic properties with microscopic model

time=0

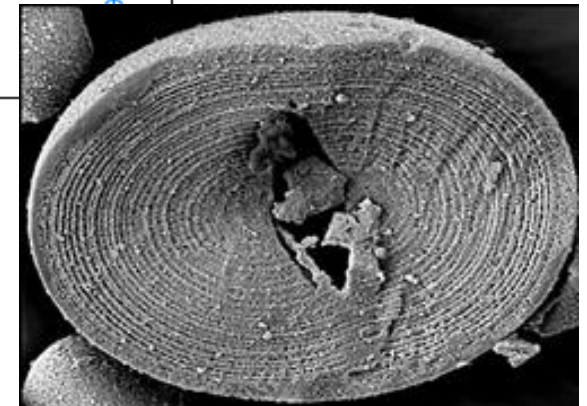
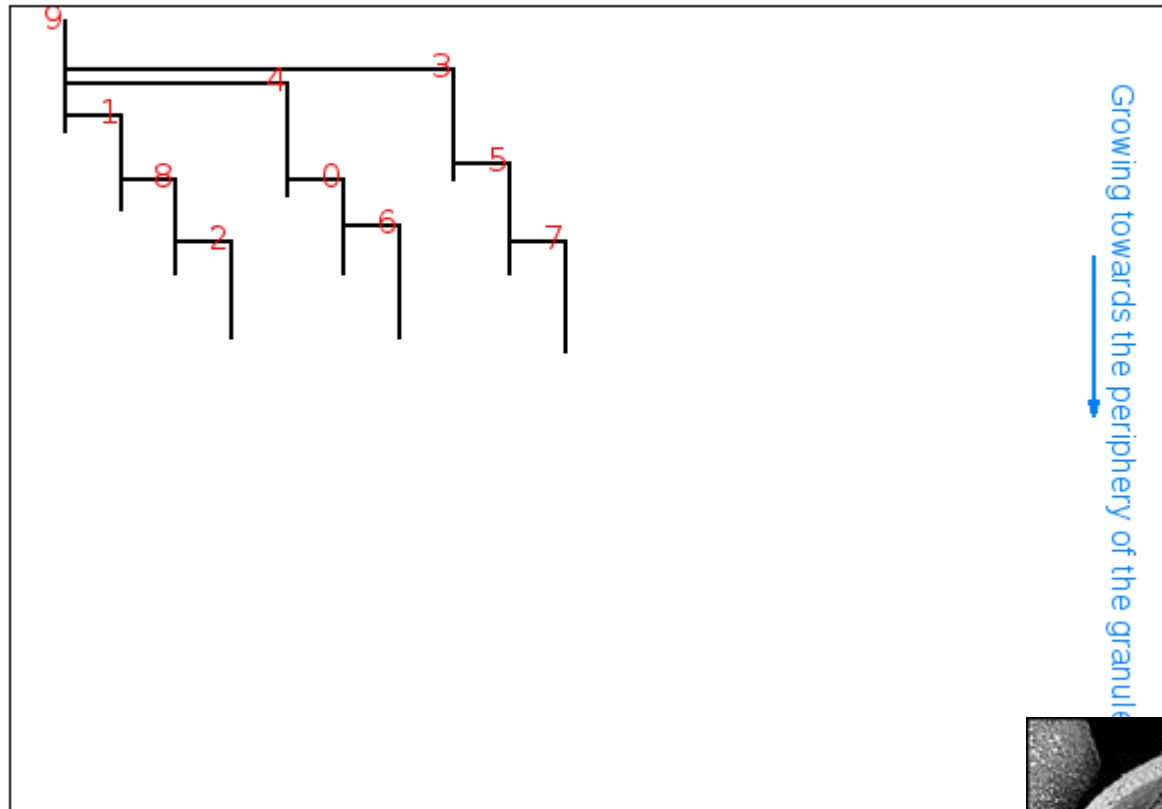

Top-down: expressing starch-like polymers in yeast

STARCH IN YEAST?



Barbara Pfister

- Delete all 7 glycogen biosynthesis genes
- Progressively add Arabidopsis genes
- All lines express AGPase and both BE isoforms
- Variable combinations of starch synthases with the presence/absence of ISA

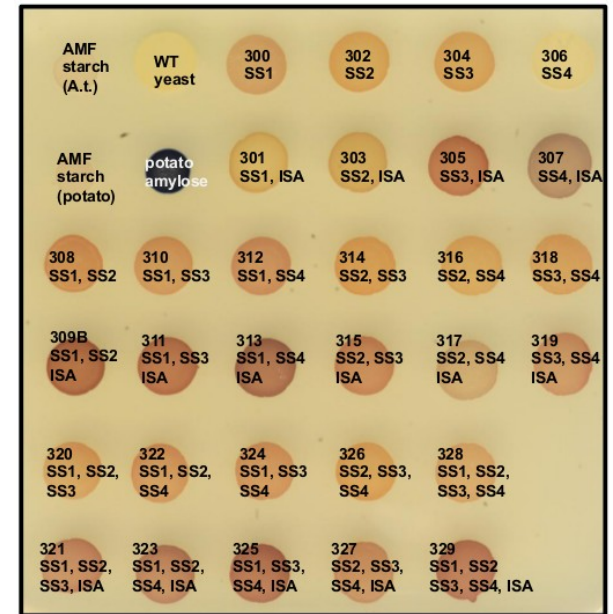
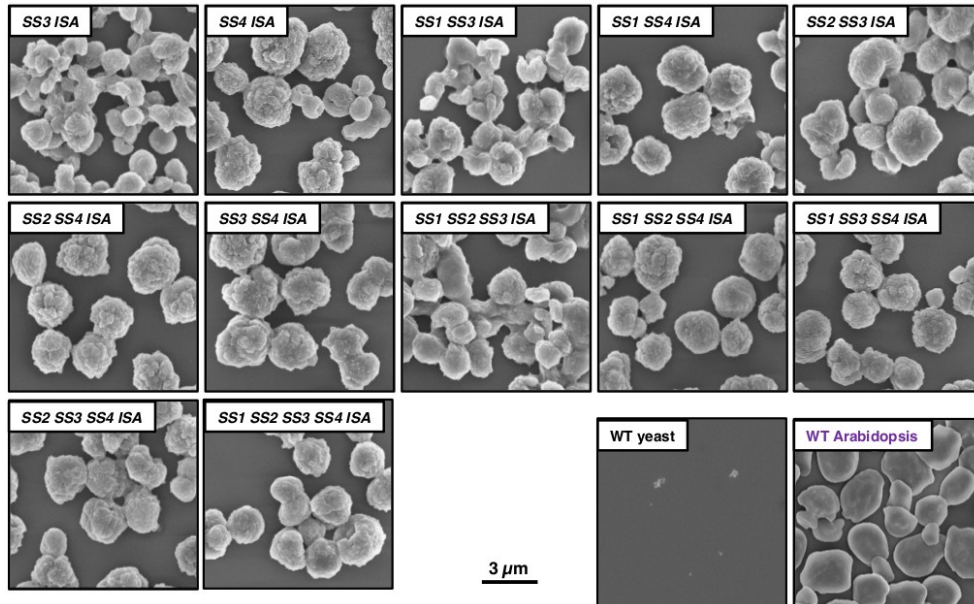

Iodine-stained galactose plate

Conclusion & Outlook:

- We are only beginning to understand...
- We get something that looks like starch, but is not!
- How does this actually work?
- How can we control the properties of the insoluble glucans?

Where else do find entropic enzymes?

...for example

Maltosyltransferases in *Streptomyces*

“Acceptor specificity”
can be explained by
entropic principles

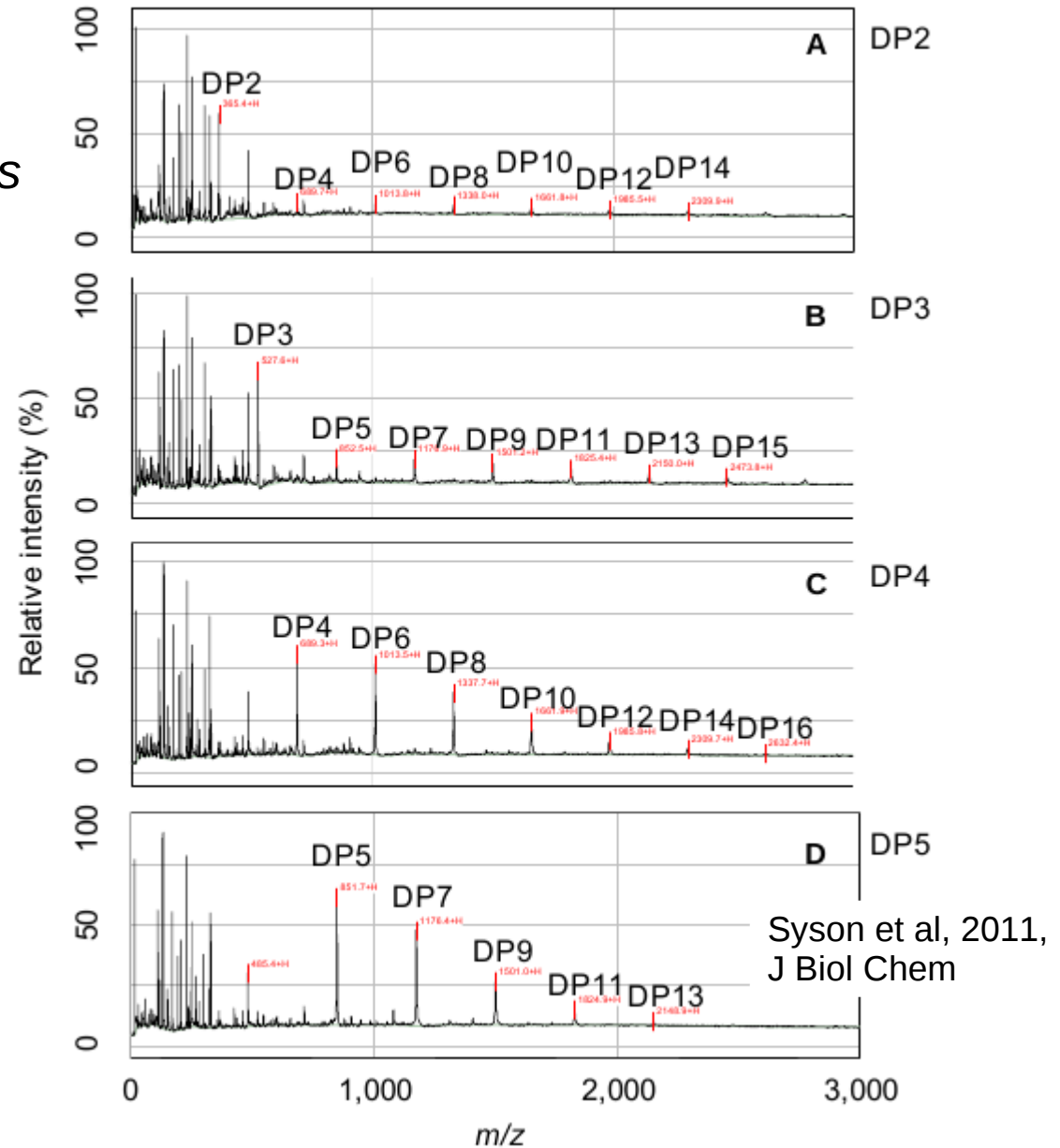
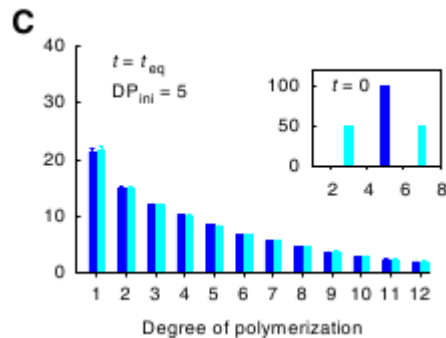
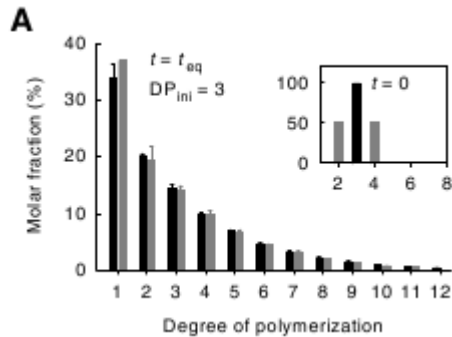

Where else do find entropic enzymes?

...or even in central metabolism?



Transketolase? $K_n + A_m \Leftrightarrow A_{n-2} + K_{m+2}$

Why only $n=5,6,7$ und $m=3,4,5$?

Why should there be no octuloses / nonuloses...?

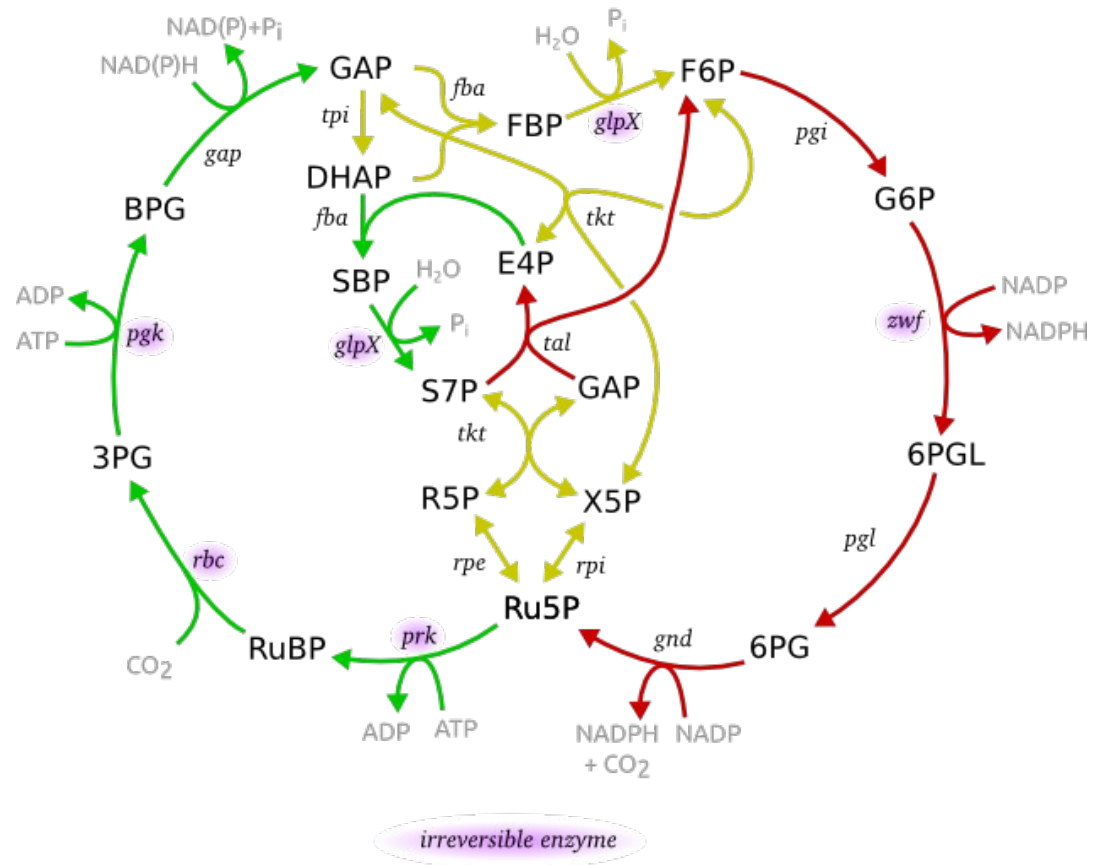

Octulose-8P oscillates in respiratory cycle in yeast

Data from Douglas Murray (unpublished), Keio University, Tsuruoka, Japan showing metabolite levels over yeast oscillatory cycles, including Octulose-8-phosphate

O8P oscillations in phase with other PPP intermediates

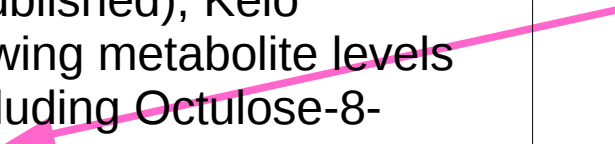

Calvin cycle energetics

TABLE IV

FREE ENERGY CHANGES OF THE PENTOSE PHOSPHATE CYCLES IN *C. pyrenoidosa*

Reaction	$\Delta G'$ (kcal)	ΔG^s (kcal)	
<i>Reductive cycle</i>			
(A) $\text{CO}_2 + \text{Ribul-1,5-}P_2^{4-} + \text{H}_2\text{O} \rightarrow 2 \text{ 3-}P\text{-glycerate}^{3-} + 2 \text{ H}^+$	-8.4	-9.8	R
(B) $\text{H}^+ + 3\text{-}P\text{-glycerate}^{3-} + \text{ATP}^{4-} + \text{NADPH} \rightarrow \text{ADP}^{3-} + \text{glyceraldehyde-3-}P^{2-} + \text{NADP}^+ + P_1^{2-}$	+4.3	-1.6	
(C) $\text{Glyceraldehyde-3-}P^{2-} \rightarrow \text{dihydroxyacetone-}P^{2-}$	-1.8	-0.2	
(D) $\text{Glyceraldehyde-3-}P^{2-} + \text{dihydroxyacetone-}P^{2-} \rightarrow \text{Fru-1,6-}P_2^{4-}$	-5.2	-0.4	
(E) $\text{Fru-1,6-}P_2^{4-} + \text{H}_2\text{O} \rightarrow \text{Fru-6-}P^{2-} + P_1^{2-}$	-3.4	-6.5	R
(F) $\text{Fru-6-}P^{2-} + \text{glyceraldehyde-3-}P^{2-} \rightarrow \text{Ery-4-}P^{2-} + \text{Xyl-5-}P^{2-}$	+1.5	-0.9	
(G) $\text{Ery-4-}P^{2-} + \text{dihydroxyacetone-}P^{2-} \rightarrow \text{Sed-1,7-}P_2^{4-}$	-5.6	-0.2	
(H) $\text{Sed-1,7-}P_2^{4-} + \text{H}_2\text{O} \rightarrow \text{Sed-7-}P^{2-} + P_1^{2-}$	-3.4	-7.1	R
(I) $\text{Sed-7-}P^{2-} + \text{glyceraldehyde-3-}P^{2-} \rightarrow \text{Rib-5-}P^{2-} + \text{Xyl-5-}P^{2-}$	+0.1	-1.4	
(J) $\text{Rib-5-}P^{2-} \rightarrow \text{Ribul-5-}P^{2-}$	+0.5	-0.1	
(K) $\text{Xyl-5-}P^{2-} \rightarrow \text{Ribul-5-}P^{2-}$	+0.2	-0.1	
(L) $\text{Ribul-5-}P^{2-} + \text{ATP}^{4-} \rightarrow \text{Ribul-1,5-}P_2^{4-} + \text{ADP}^{3-} + \text{H}^+$	-5.2	-3.8	R'
(M) $\text{Fru-6-}P^{2-} \rightarrow \text{Glc-6-}P^{2-}$	-0.5	-0.3	
(N) $\text{Glc-6-}P^{2-} + \text{H}_2\text{O} \rightarrow \alpha\text{-D-Glc} + P_1^{2-}$	-3.3	(-7.2)*	

Iso
Ald
TK
Ald
TK
Iso
Iso
Iso

(Bassham and Krause, BBA 1969)

All 'close to equilibrium' reactions *shuffle*

Thermodynamic organisation of metabolism

Photograph not shown because of potential copyright issues

tr.walls321.com – Pamukkale, Turkey

CBB cycle energetics support this!

Photograph not shown because of potential copyright issues

or

?

www.alamy.com – Loch Fyne, Scotland

The Logic of the CBB

- 1) Near equilibrium reactions mix sugar phosphates, providing a range of substrates

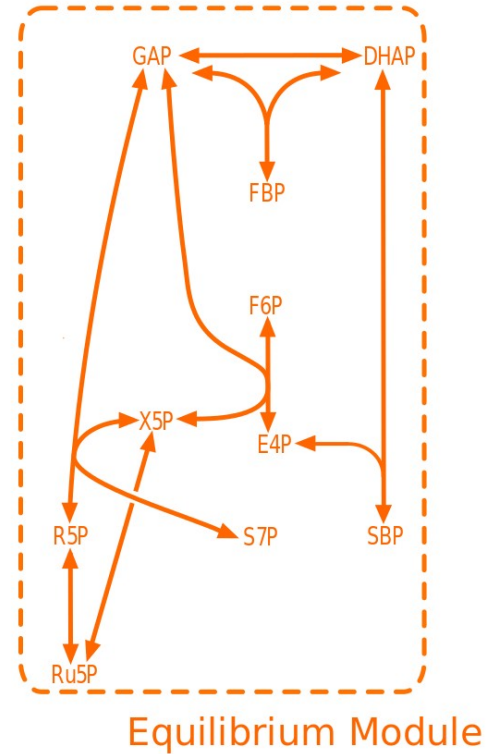

The Logic of the CBB

- 1) Near equilibrium reactions mix sugar phosphates, providing a range of substrates
- 2) De-phosphorylation as thermodynamic driving force ($\Delta G < 0$)

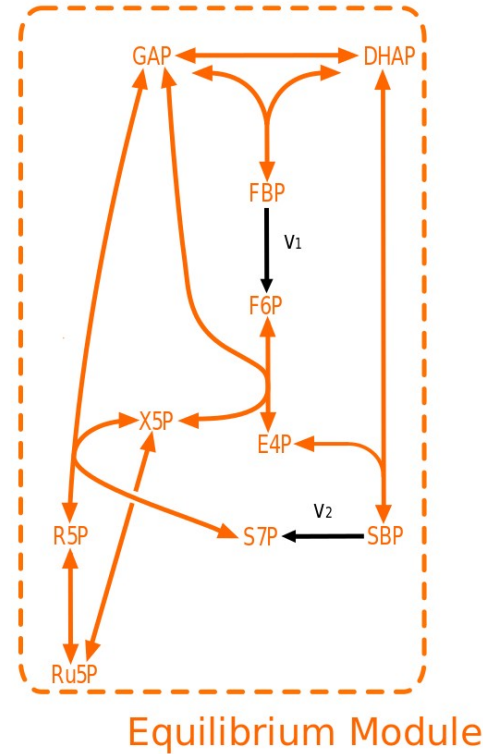

The Logic of the CBB

- 1) Near equilibrium reactions mix sugar phosphates, providing a range of substrates
- 2) De-phosphorylation as thermodynamic driving force ($\Delta G < 0$)
- 3) Activation, carbon fixation, reduction (overall $\Delta G < 0$)

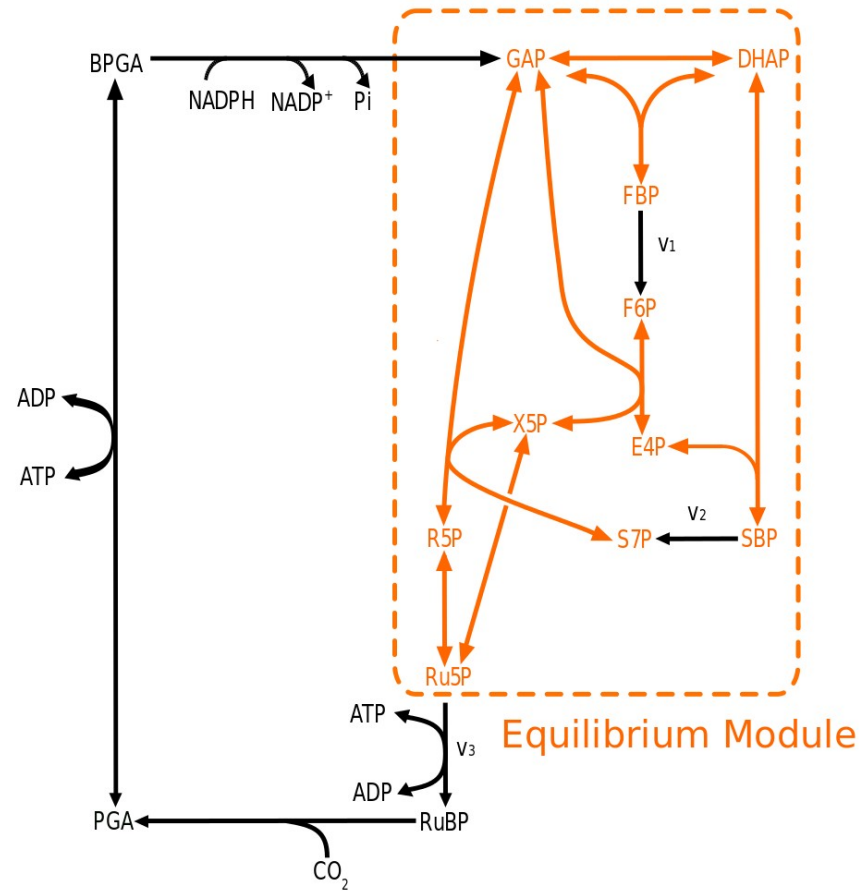

The Logic of the CBB

- 1) Near equilibrium reactions mix sugar phosphates, providing a range of substrates
- 2) De-phosphorylation as thermodynamic driving force ($\Delta G < 0$)
- 3) Activation, carbon fixation, reduction (overall $\Delta G < 0$)
- 4) Output

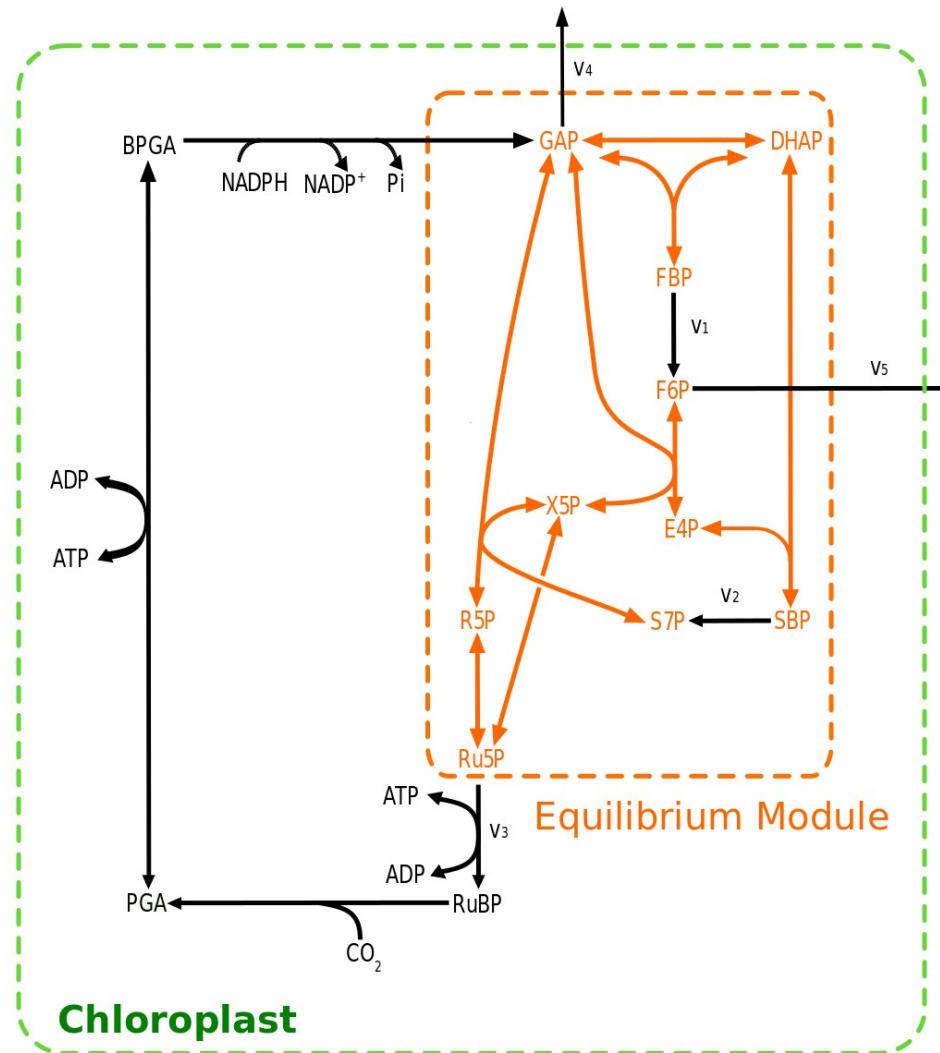

The pentose phosphate pathways uses the same equilibrium module

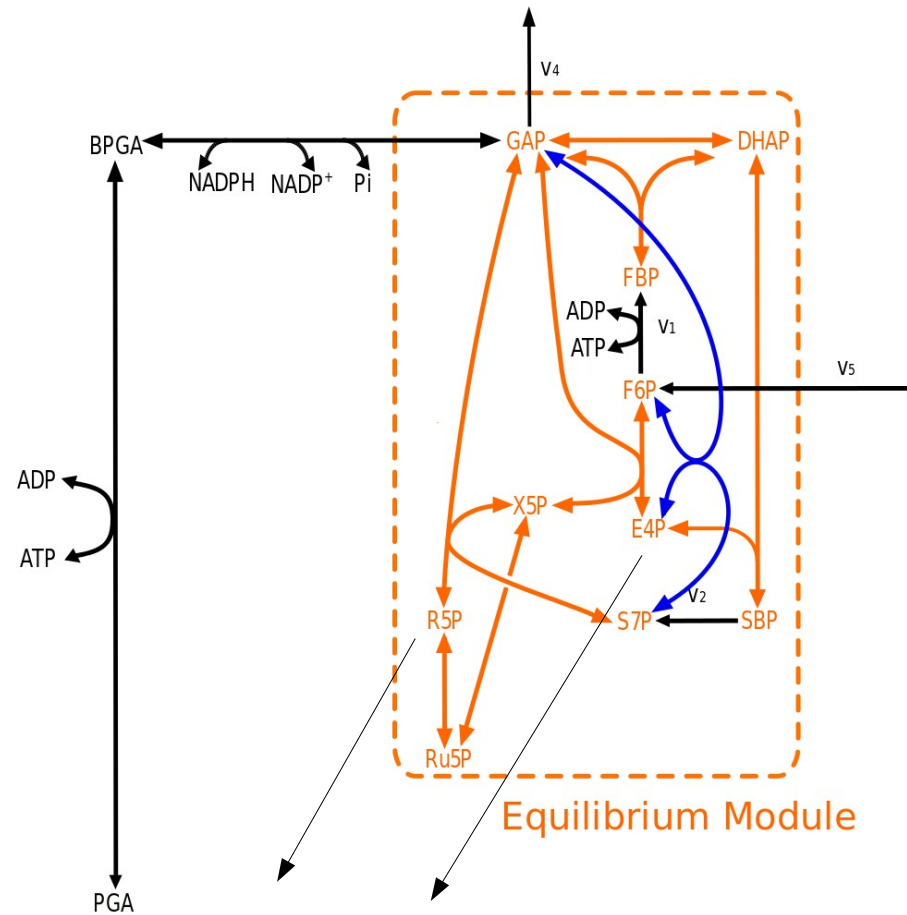

The Equilibrium Module

How to calculate the rapid equilibrium?

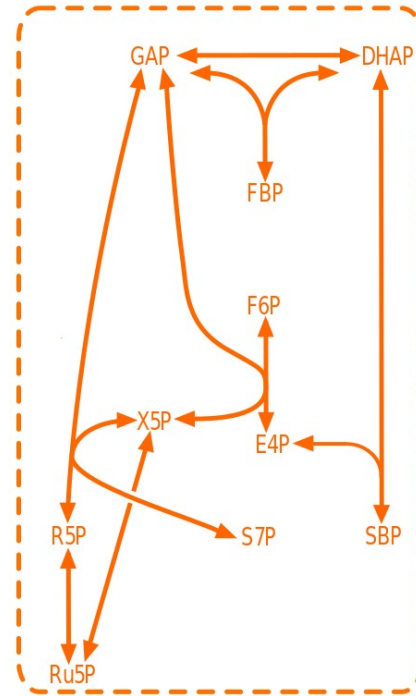

Equilibrium Module

The Equilibrium Module

How to calculate the rapid equilibrium?

Thermodynamics

(see Supplementary to Kartal et al, 2011, MSB 7:542)

- Step 1: find conserved quantities

Formally:

$$N_{eq} = \begin{matrix} \text{Iso} \\ \text{TPP} \\ \text{RPI} \\ \text{RPE} \end{matrix} \begin{matrix} \text{TK} & \text{Ald} \end{matrix} \begin{matrix} \text{GAP} \\ \text{DHAP} \\ \text{E4P} \\ \text{X5P} \\ \text{R5P} \\ \text{Ru5P} \\ \text{F6P} \\ \text{S7P} \\ \text{FBP} \\ \text{SBP} \end{matrix} \begin{bmatrix} -1 & -1 & -1 \\ 1 & -1 & -1 \\ & 1 & -1 \\ & -1 & 1 \\ & -1 & 1 \\ & 1 & 1 \\ -1 & & \\ & -1 & \\ & & 1 \\ & & 1 \end{bmatrix}$$

Linearly independent solutions to $c \cdot N_{eq} = 0$:

$$c_1 = (1, 1, 0, 1, 1, 1, 0, 1, 2, 1)$$

$$c_2 = (0, 0, 1, 0, 0, 0, 1, 0, 0, 1)$$

$$c_3 = (0, 0, 1, 2, 2, 2, 3, 4, 0, 1)$$

$$P_1 = \text{GAP} + \text{DHAP} + \text{X5P} + \text{R5P} + \text{Ru5P} + \text{S7P} + 2\text{FBP} + \text{SBP}$$

$$P_2 = \text{E4P} + \text{F6P} + \text{SBP}$$

$$Q = \text{E4P} + 2(\text{X5P} + \text{R5P} + \text{Ru5P}) + 3\text{F6P} + 4\text{S7P} + \text{SBP}$$

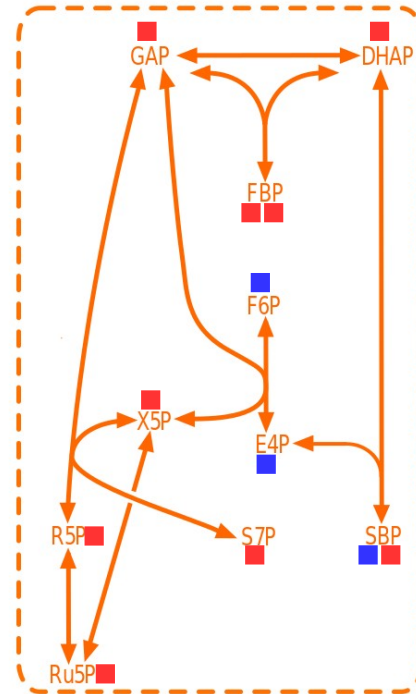

3 conserved moieties:
2 from P, 1 from C

- P in odd-C sugars
- P in even-C sugars

Equilibrium Module

The Equilibrium Module

How to calculate the rapid equilibrium?

Thermodynamics

(see Supplementary to Kartal et al, 2011, MSB 7:542)

- Step 2: minimise Gibbs free energy

How to find the function

$$f : (P_1, P_2, Q) \rightarrow \underbrace{(GAP, DHAP, E4P, XSP, R5P, Ru5P, F6P, S7P, FBP, SBP)}_M ?$$

THERMODYNAMIC APPROACH:

$$G = \sum_{j \in M} x_j \mu_j + RT \cdot \sum_{j \in M} x_j \cdot (\ln x_j - 1)$$

Gibbs energies of formation

$T \cdot$ mixing entropy

x_j : concentrations

μ_j : chemical potentials

Minimise G under constraints $C \cdot N = 0$

→ LAGRANGIAN MULTIPLIERS !

Solving the equilibrium module

3 equations with 3 unknowns:

$$\begin{aligned}
 P_1 &= \boxed{x_0} \left(f_0 + \kappa_2 f_2 \boxed{z} + \kappa_4 f_4 z^2 \right) + 2g x_0^2 + g_1 x_0 \boxed{x_1} \\
 P_2 &= x_1 (1 + \kappa_3 z) + g_1 x_0 x_1 \\
 Q &= x_0 (2f_2 \kappa_2 z + 4f_4 \kappa_4 z^2) + x_1 (1 + 3\kappa_3 z) + g_1 x_0 x_1
 \end{aligned}$$

Notation:

x_k : compound with $k+3$ carbons

$$\implies x_{k+2} = x_k \cdot e^{-\Delta\mu} \cdot z$$

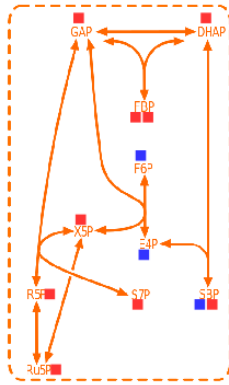

■ P_1 ■ P_2
 $Q = C - 3P$

A 3-variable model of the CBB cycle

Stoichiometry Matrix:

$$N = \begin{bmatrix} -2 & 0 & 1 & -1 & 0 \\ 1 & -1 & 0 & 0 & -1 \\ 3 & 3 & -2 & 0 & -3 \end{bmatrix} \begin{matrix} P_1 \\ P_2 \\ Q \end{matrix}$$

Differential Equations:

$$\dot{X} = N \cdot v(Y(X))$$

with:

$$X = \{P_1, P_2, Q\}$$

$$Y = \{GAP, DHAP, E4P \dots SBP\}$$

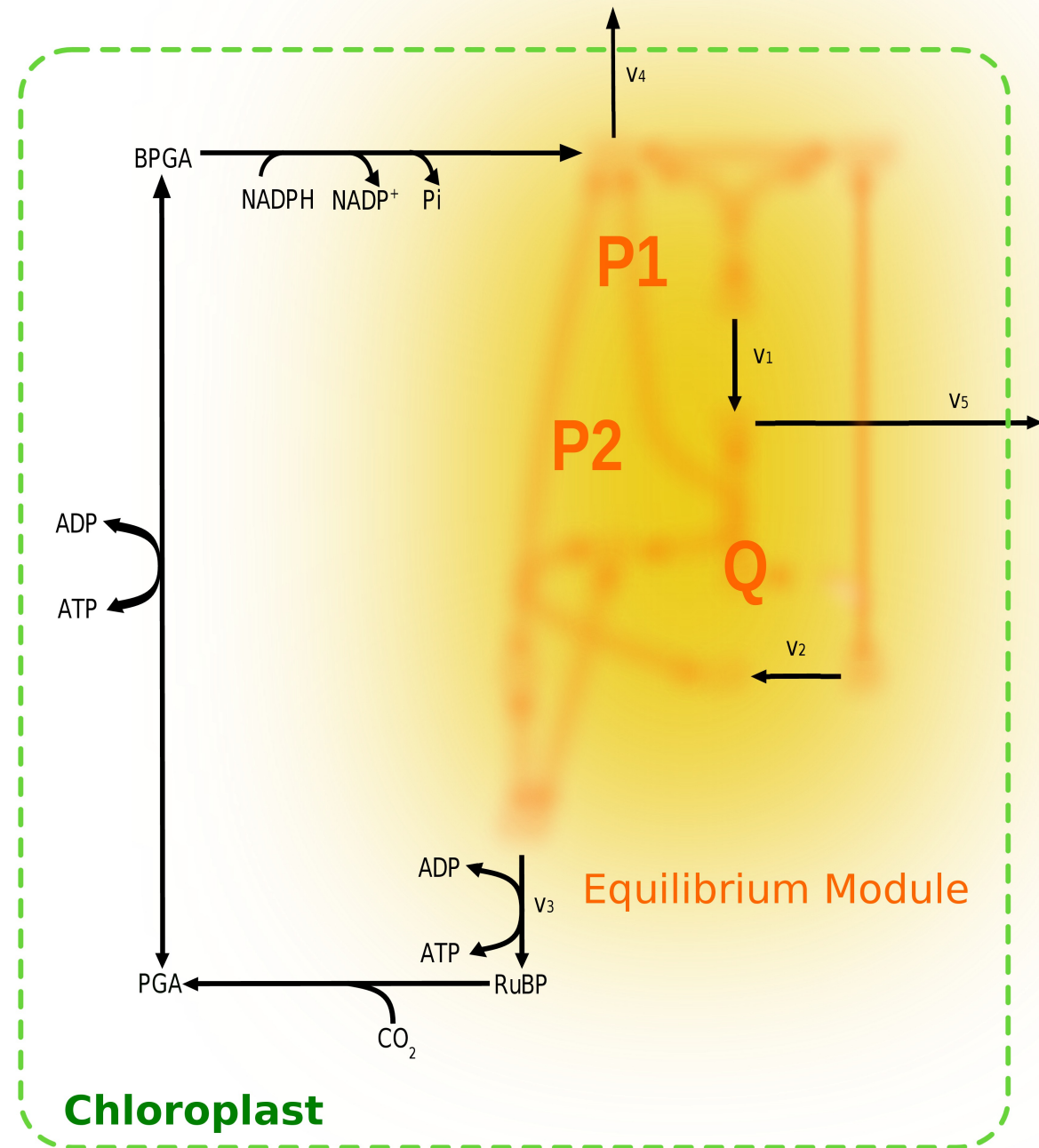

Closing the cycle

First attempt: mass-action

$$v_1 = k_1[\text{FBP}]$$

$$v_2 = k_2[\text{SBP}]$$

$$v_3 = k_3[\text{Ru5P}]$$

$$v_4 = k_4[\text{GAP}]$$

$$v_5 = k_5[\text{F6P}]$$

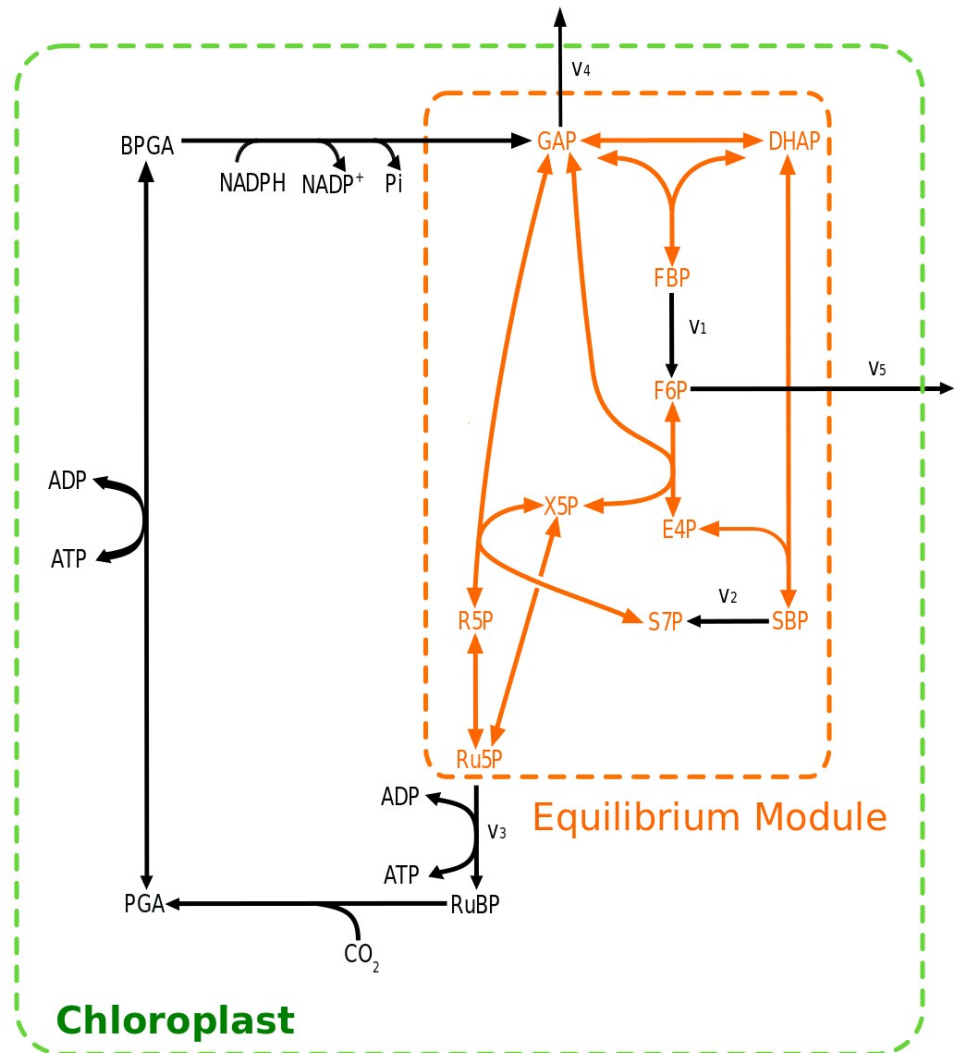

Closing the cycle

First attempt: mass-action

$$v_1 = k_1 [\text{FBP}]$$

$$v_2 = k_2 [\text{SBP}]$$

$$v_3 = k_3 [\text{Ru5P}]$$

$$v_4 = k_4 [\text{GAP}]$$

$$v_5 = k_5 [\text{F6P}]$$

UNSTABLE!

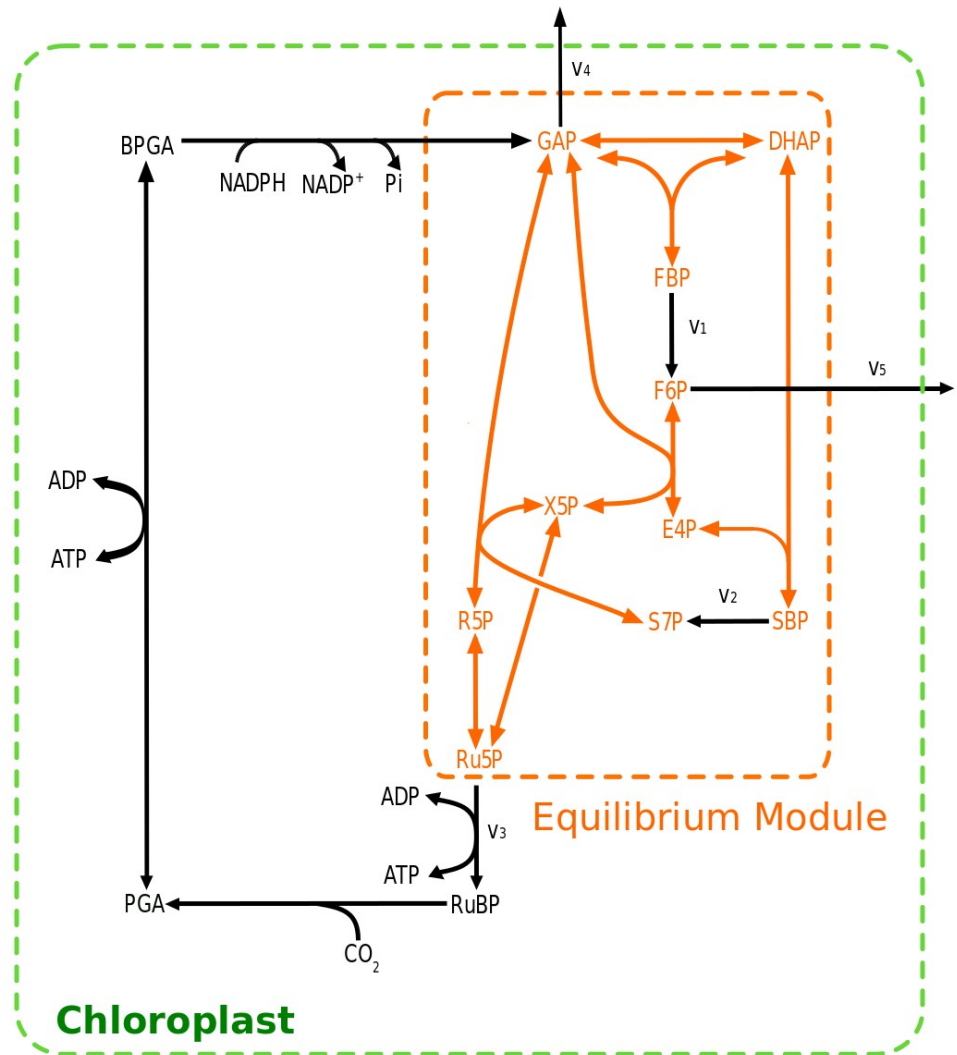
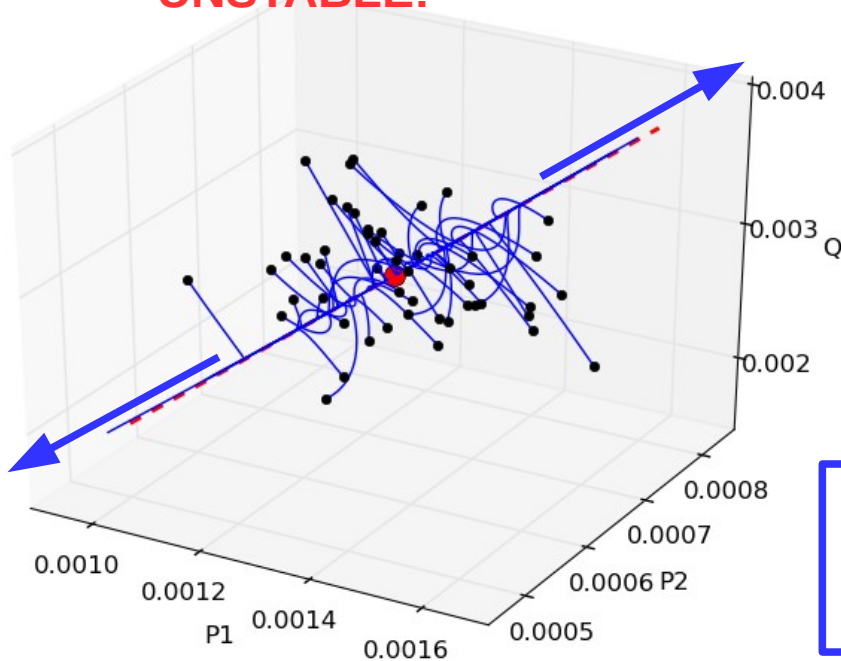

Trajectories diverge in direction of eigenvector belonging to (the only) positive eigenvalue of Jacobian

Closing the cycle

Second attempt: Michaelis-Menten

$$v_1 = V_{\max 1} [\text{FBP}] / (K_{M1} + [\text{FBP}])$$

$$v_2 = V_{\max 2} [\text{SBP}] / (K_{M2} + [\text{SBP}])$$

$$v_3 = V_{\max 3} [\text{Ru5P}] / (K_{M3} + [\text{Ru5P}])$$

$$v_4 = V_{\max 4} [\text{GAP}] / (K_{M4} + [\text{GAP}])$$

$$v_5 = V_{\max 5} [\text{F6P}] / (K_{M5} + [\text{F6P}])$$

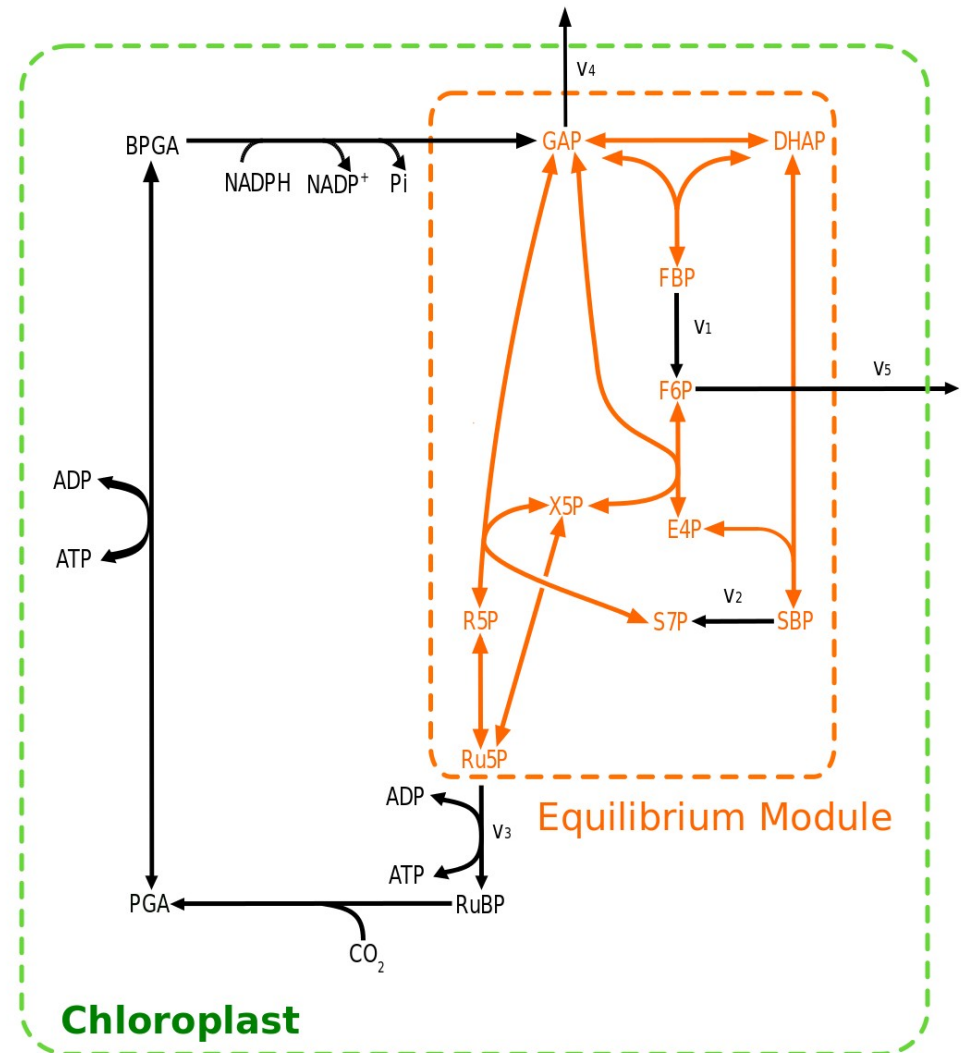

Closing the cycle

Second attempt: Michaelis-Menten

$$v_1 = V_{\max 1} [\text{FBP}] / (K_{M1} + [\text{FBP}])$$

$$v_2 = V_{\max 2} [\text{SBP}] / (K_{M2} + [\text{SBP}])$$

$$v_3 = V_{\max 3} [\text{Ru5P}] / (K_{M3} + [\text{Ru5P}])$$

$$v_4 = V_{\max 4} [\text{GAP}] / (K_{M4} + [\text{GAP}])$$

$$v_5 = V_{\max 5} [\text{F6P}] / (K_{M5} + [\text{F6P}])$$

Finding 'good' V_{\max} / K_M - values...

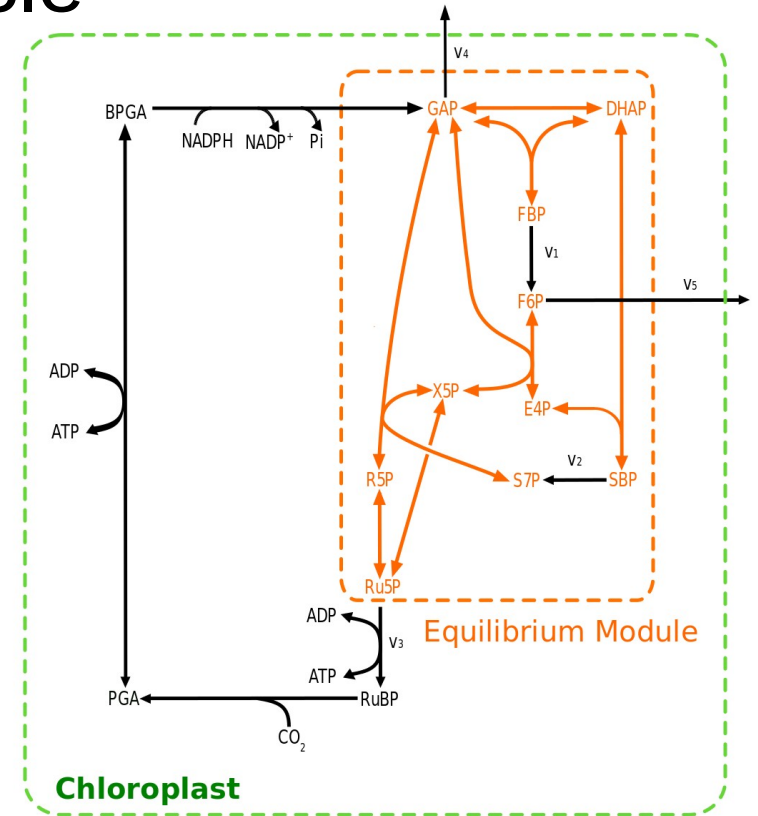

$$\dot{X} = N \cdot v(Y(X))$$

Jacobian

$$J_{ik} = \sum_j n_{ij} \left(\frac{\partial v_j}{\partial X_k} \right) \epsilon_{jk}$$

or

$$J = N \cdot E \quad \leftarrow \text{elasticities } \epsilon_{jk}$$

$$\epsilon_{jk} = \frac{\partial v_j}{\partial X_k} = \sum_r n_{jr} \frac{\partial v_r}{\partial Y_j} \cdot \frac{\partial Y_r}{\partial X_k} \quad \leftarrow \theta_{rk} \text{ (kann sein)}$$

or

$$J = N \cdot H \cdot \Theta$$

3×5 5×10 10×3

Optimising elasticities for stability

For irreversible reactions without allosteric regulation:

$$H = \begin{pmatrix} & & \epsilon_1 & & \\ & & \epsilon_2 & & \\ \epsilon_4 & & & & \\ & \epsilon_3 & & & \\ & & \epsilon_5 & & \end{pmatrix} \text{ only 5 non-zero}$$

$$J = N \cdot H \cdot \Theta$$

3×5 5×10 10×3

For mass-action kinetics $v_j = k_j \cdot X$: $\epsilon_j = k_j$

Define: $\Lambda(\epsilon_j) := \max_{\lambda} \{ \text{Re}(\lambda) : \det(\lambda \cdot \mathbb{1} - J) = 0 \}$ maximal Eigenvalue

FIND STABLE SOLUTION BY MINIMISING Λ

Optimising elasticities for stability

For irreversible reactions without allosteric regulation:

$$H = \begin{pmatrix} & & \epsilon_1 & & \\ & & \epsilon_2 & & \\ \epsilon_4 & & & & \\ & \epsilon_3 & & & \\ & & \epsilon_5 & & \end{pmatrix} \text{ only 5 non-zero}$$

$$J = N \cdot H \cdot \Theta$$

$\begin{matrix} 3 \times 5 & 5 \times 10 & 10 \times 3 \end{matrix}$

For mass-action kinetics $v_j = k_j \cdot X$: $\epsilon_j = k_j$

Define: $\Lambda(\epsilon_j) := \max_{\lambda} \{ \text{Re}(\lambda) : \det(\lambda \cdot \mathbb{1} - J) = 0 \}$ maximal Eigenvalue

FIND STABLE SOLUTION BY MINIMISING Λ

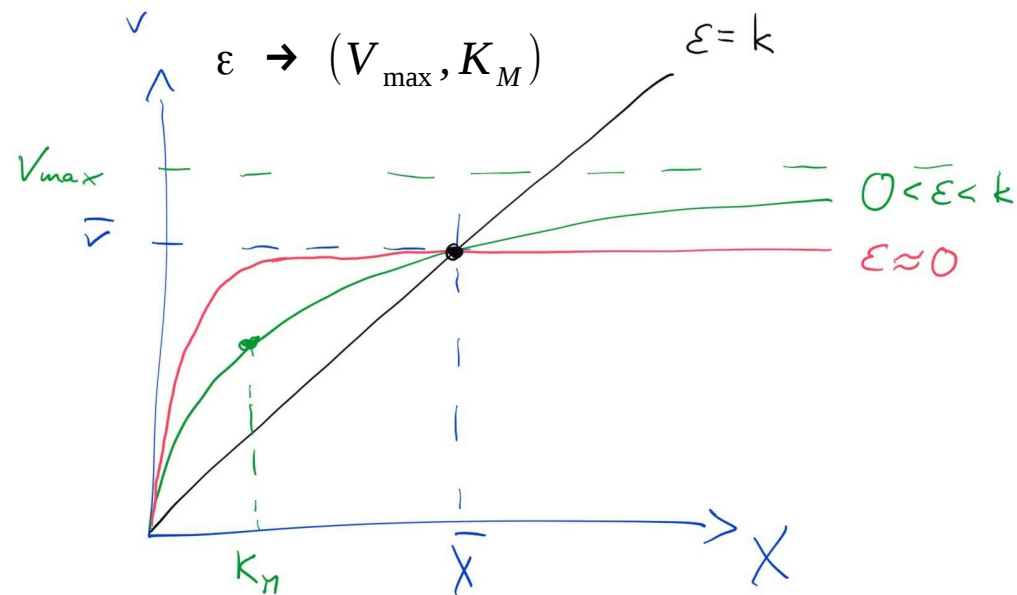

Optimising elasticities for stability

For irreversible reactions without allosteric regulation:

$$H = \begin{pmatrix} & & \epsilon_1 & & \\ & & \epsilon_2 & & \\ \epsilon_4 & & & & \\ & \epsilon_3 & & & \\ & & \epsilon_5 & & \end{pmatrix} \text{ only 5 non-zero}$$

$$J = N \cdot H \cdot \Theta$$

$\begin{matrix} 3 \times 5 & 5 \times 10 & 10 \times 3 \end{matrix}$

For mass-action kinetics $v_j = k_j \cdot X$: $\epsilon_j = k_j$

Define: $\Lambda(\epsilon_j) := \max_{\lambda} \{ \text{Re}(\lambda) : \det(\lambda \cdot \mathbb{1} - J) = 0 \}$ maximal Eigenvalue

FIND STABLE SOLUTION BY MINIMISING Λ

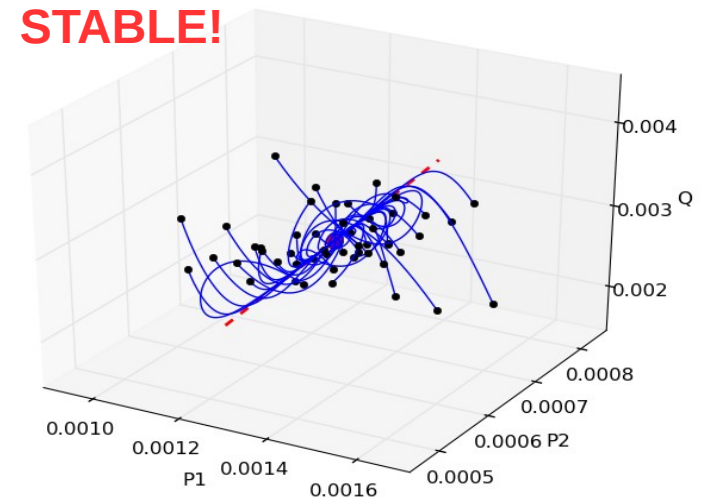
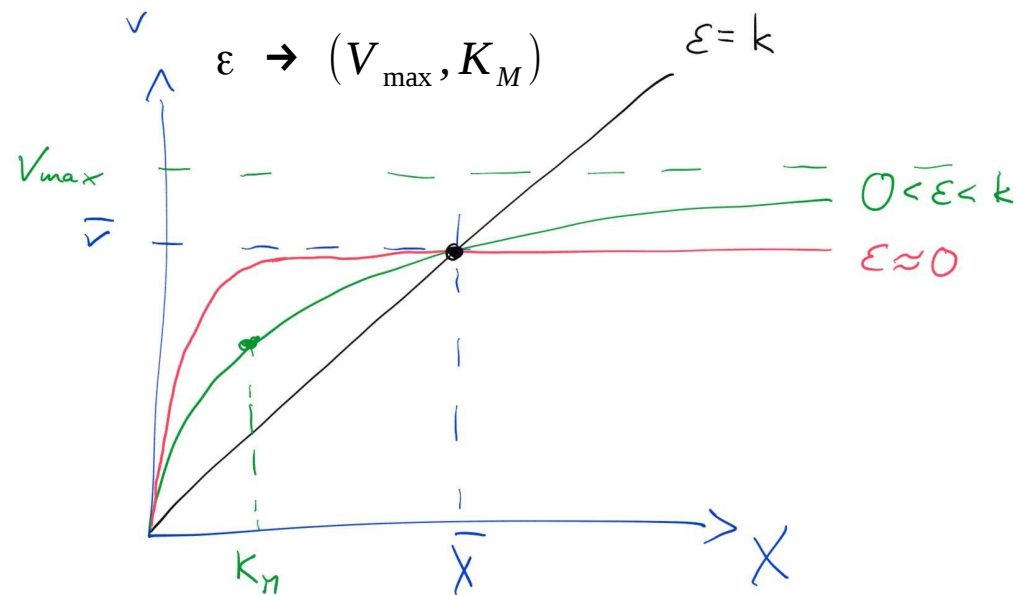

“Predicted” elasticities

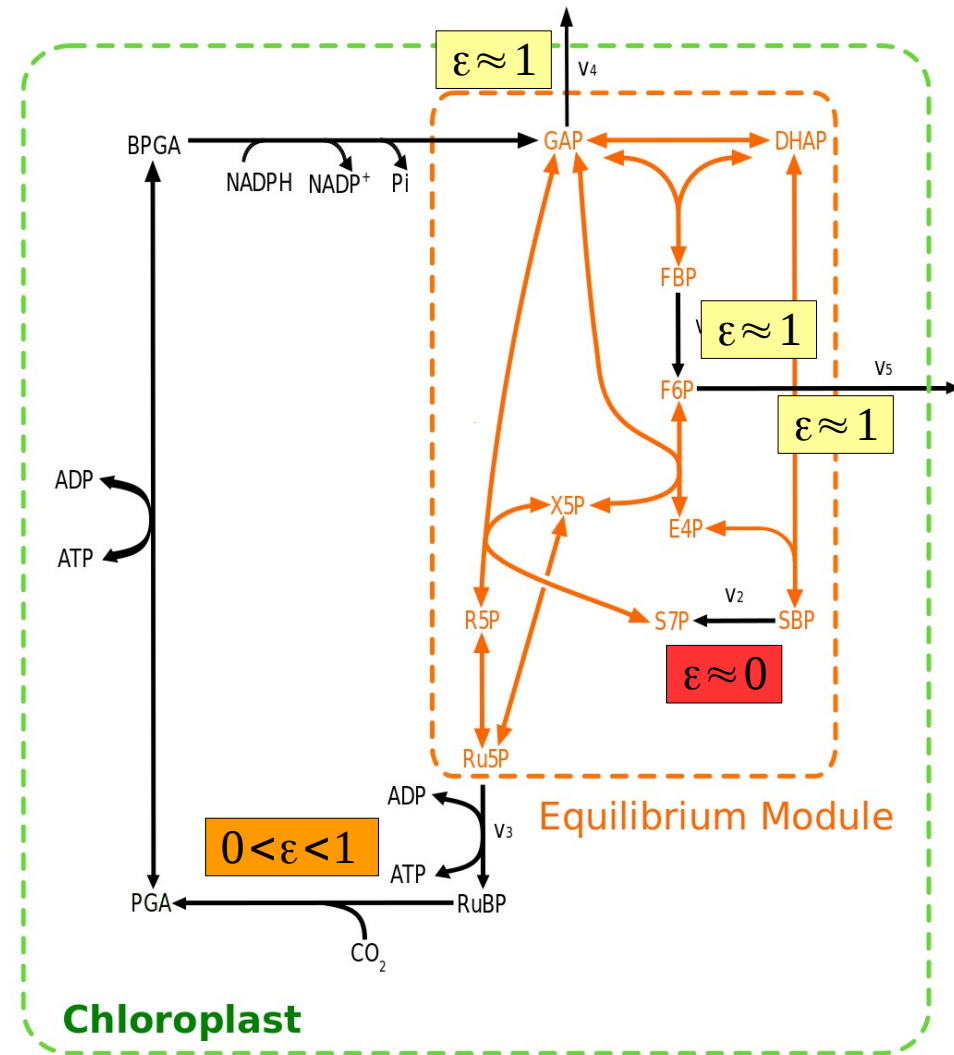
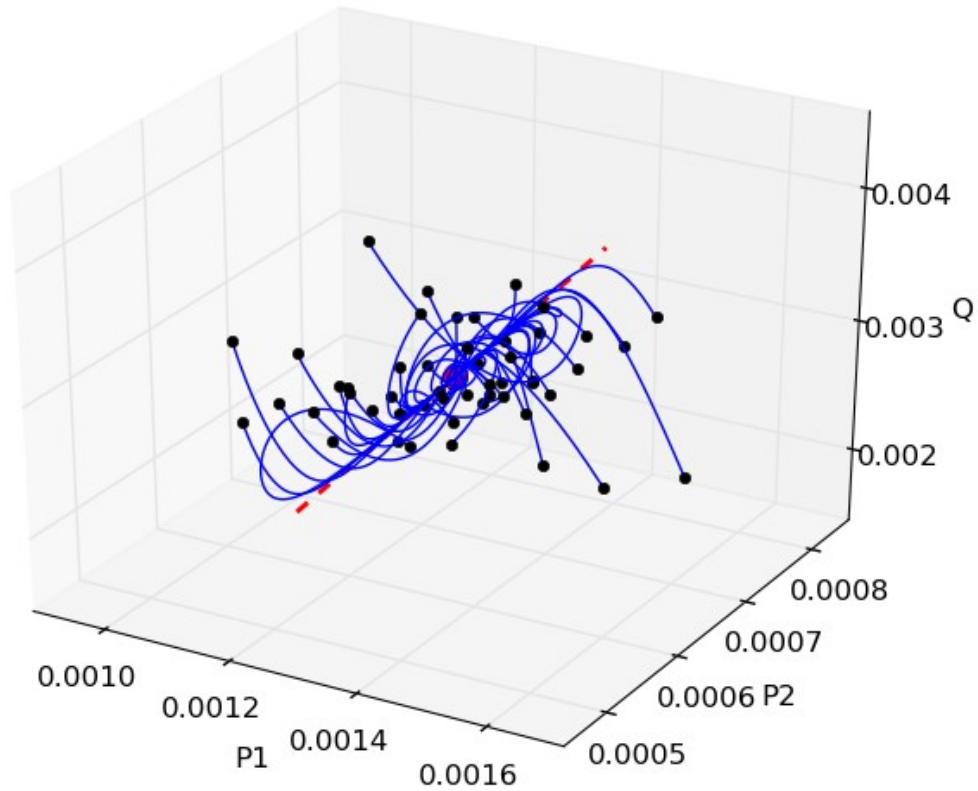

The photosynthetic Gibbs effect

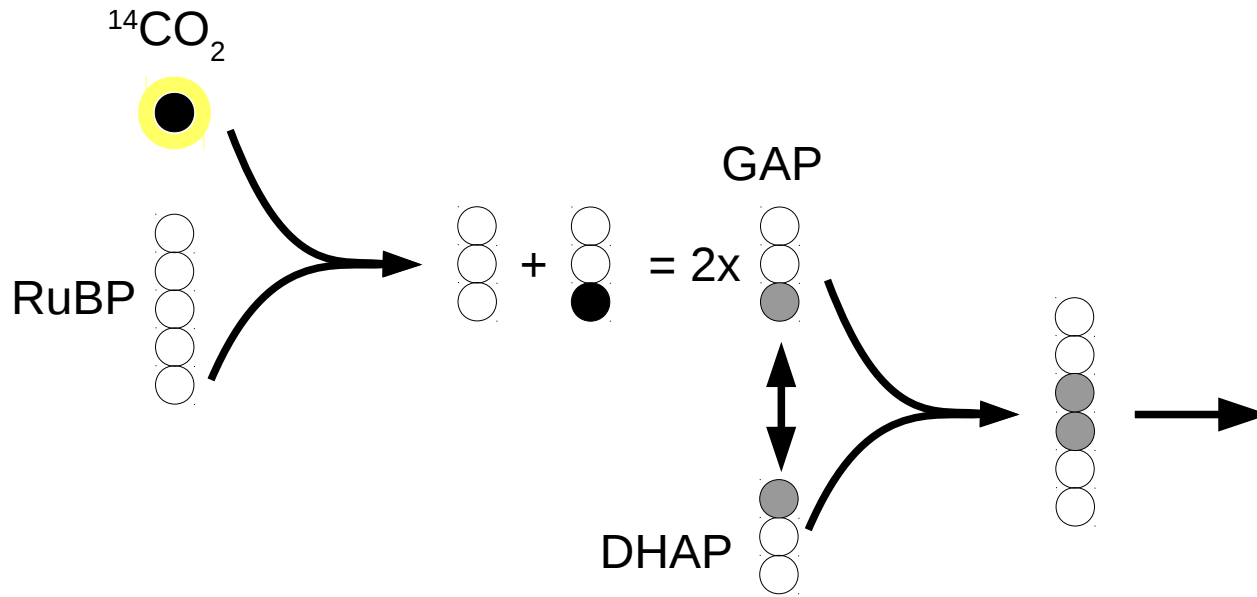

Intuitive (naïve) assumption:

Label should appear symmetrically
in position 3 and 4

The photosynthetic Gibbs effect

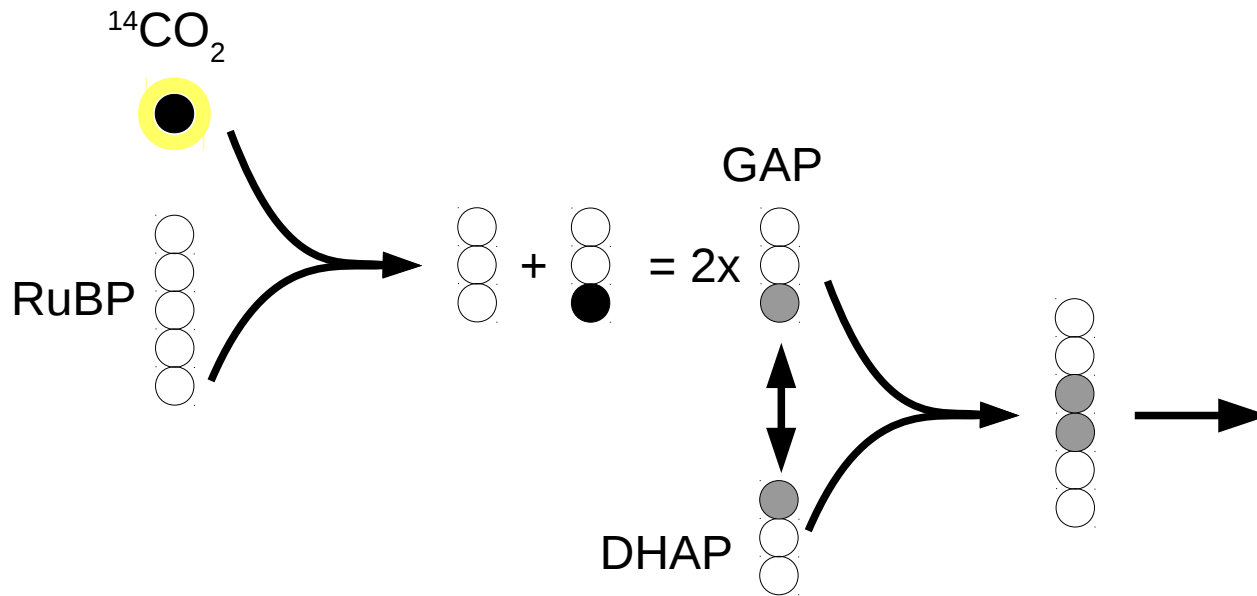

Intuitive (naïve) assumption:

Label should appear symmetrically in position 3 and 4

But (Gibbs & Kandler, 1957, PNAS): Label appears first in position 4!

TABLE 1

DISTRIBUTION OF C^{14} IN GLUCOSE

PLANT	LIGHT INTENSITY (FOOT-CANDLES)	TIME	GLUCOSE SOURCE	—TRACER CONTENT OF GLUCOSE CARBON ATOMS— ($\text{M}\mu\text{C}/\text{mgC}$)					
				1	2	3	4	5	6
<i>Chlorella</i> *	4,000	10 sec.	Starch	0.35	0.27	3.67	4.90	0.10	0.16
<i>Chlorella</i> †	4,000	60 sec.	Starch	1.16	1.15	5.16	7.00	0.42	0.46
<i>Chlorella</i> ‡	700	45 min.	Starch	22.5	22.8	25.4	26.4	22.5	23.3
Tobacco§	4,000	50 sec.	Starch	2.69	4.30	11.0	18.6	1.17	2.99
Tobacco§	100	180 sec.	Starch	8.55	10.7	25.9	37.5	9.12	8.21
Sunflower§	70	15 min.	Sucrose	0.55	0.60	1.20	2.29	0.48	0.54
Canna	2,000	24 hrs.	Sucrose	5.36	5.16	5.19	5.08	5.08	5.12

Simple explanation for 3 and 4

Different pool sizes of GAP and DHAP (Bassham, 1964, Ann. Rev. Plant Phys.)

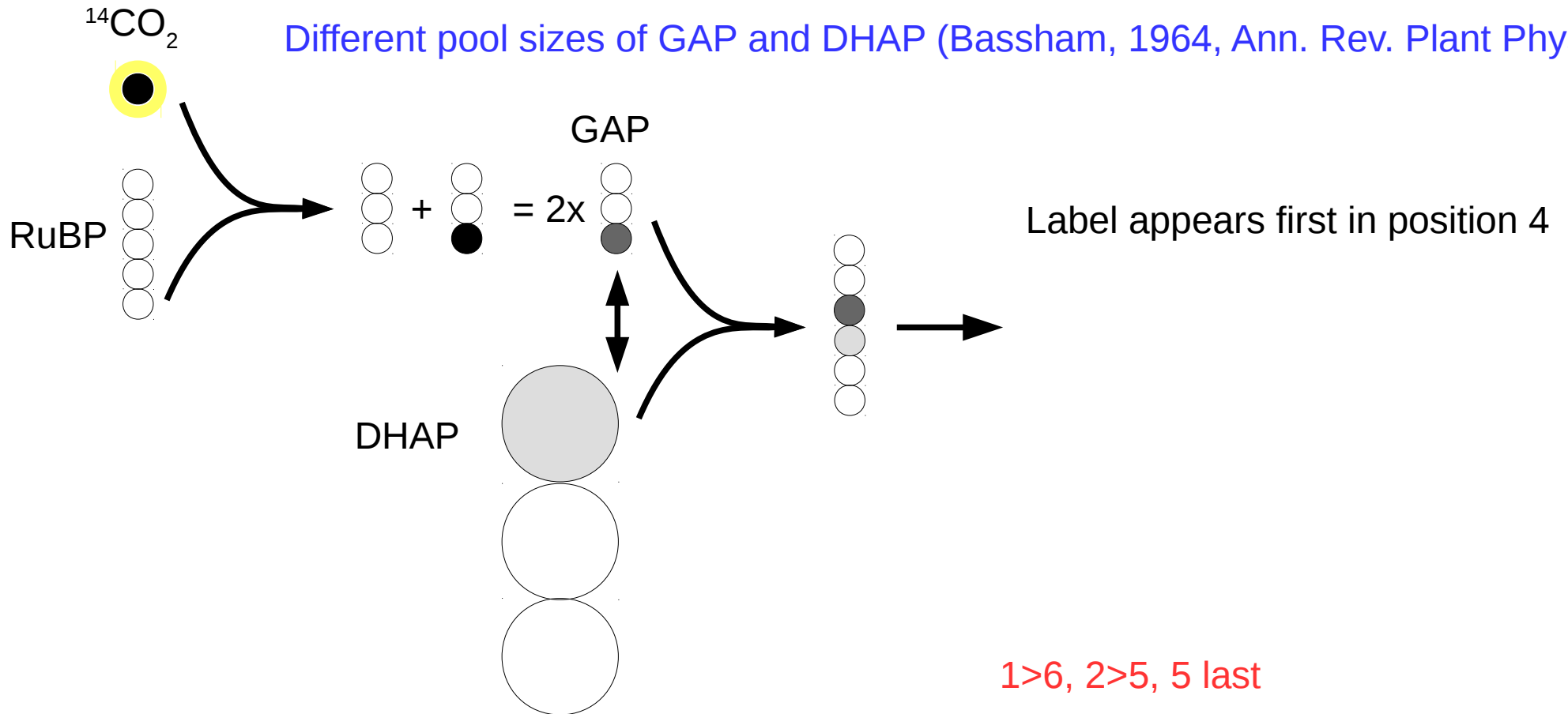

1>6, 2>5, 5 last

What about the other positions?

Bassham 1964:
 "...because of the reversibility of
 transketolase..."

GLUCOSE SOURCE	TRACER CONTENT OF GLUCOSE CARBON ATOMS (MμC/MGC)					
	1	2	3	4	5	6
Starch	0.35	0.27	3.67	4.90	0.10	0.16
Starch	1.16	1.15	5.16	7.00	0.42	0.46
Starch	22.5	22.8	25.4	26.4	22.5	23.3
Starch	2.69	4.30	11.0	18.6	1.17	2.99
Starch	8.55	10.7	25.9	37.5	9.12	8.21

A dynamic model of isotope label distribution

Workflow

- stable Michaelis-Menten model, as developed above
- parameters to fit some measured steady-state
- multiply each metabolite by all possible isotope patterns ($2^{\#C}$):
total 512 metabolites
- multiply each reaction by all possible isotope patterns of substrates:
total 13368 rate expressions

A dynamic model of isotope label distribution

Workflow

- stable Michaelis-Menten model, as developed above
- parameters to fit some measured steady-state
- multiply each metabolite by all possible isotope patterns ($2^{\#C}$):
total 512 metabolites
- multiply each reaction by all possible isotope patterns of substrates:
total 13368 rate expressions

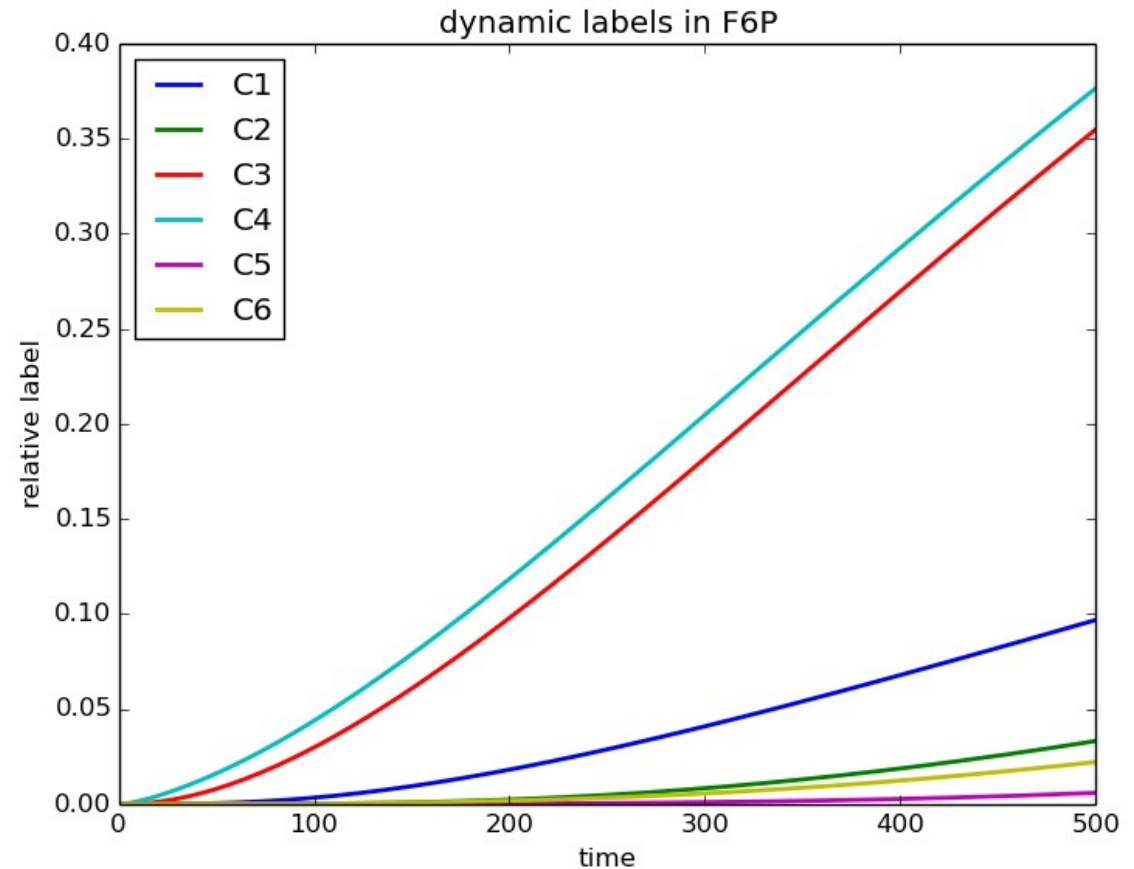

Slow TPI pronounces asymmetry

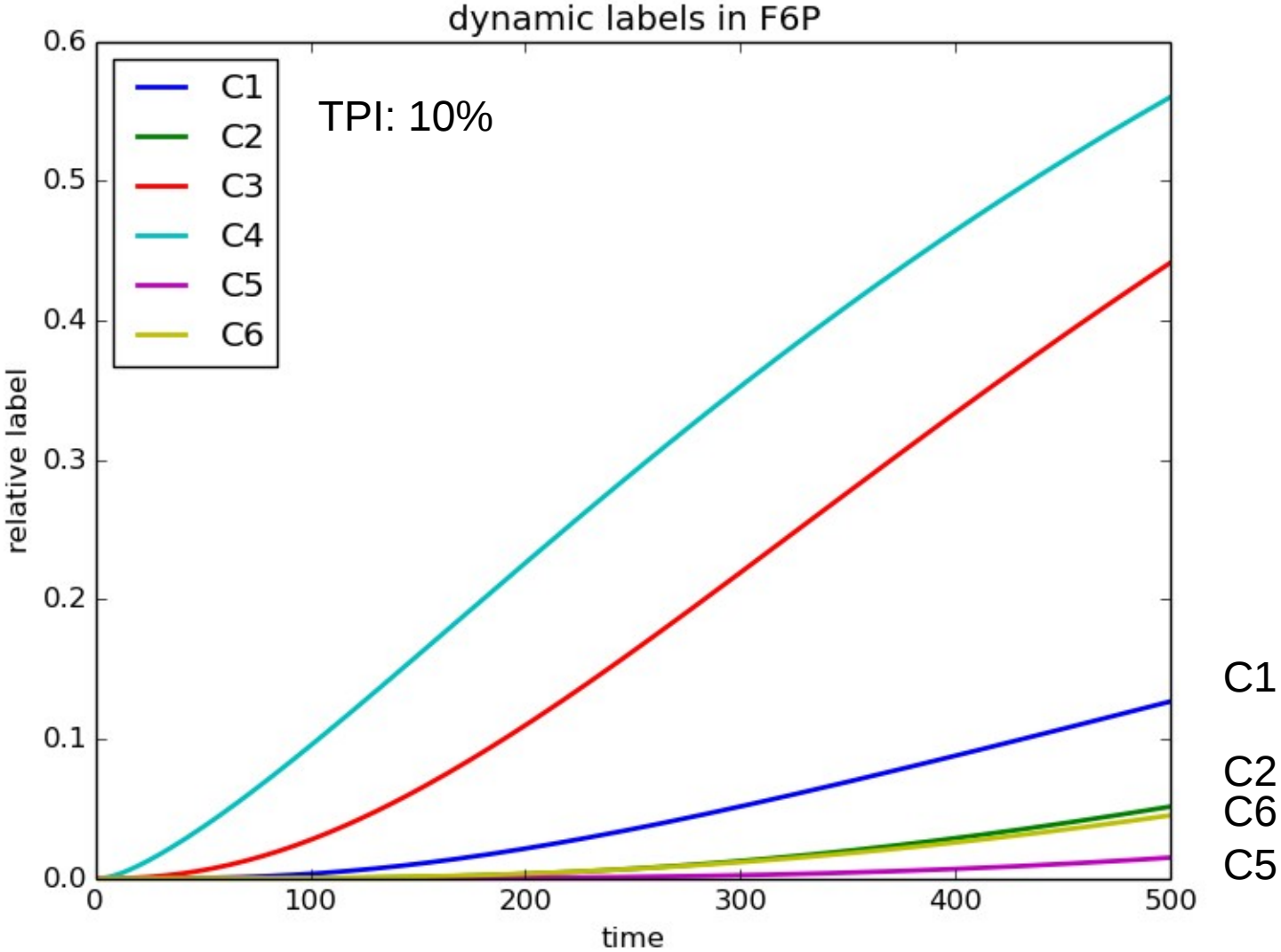

TK activity influences other labels

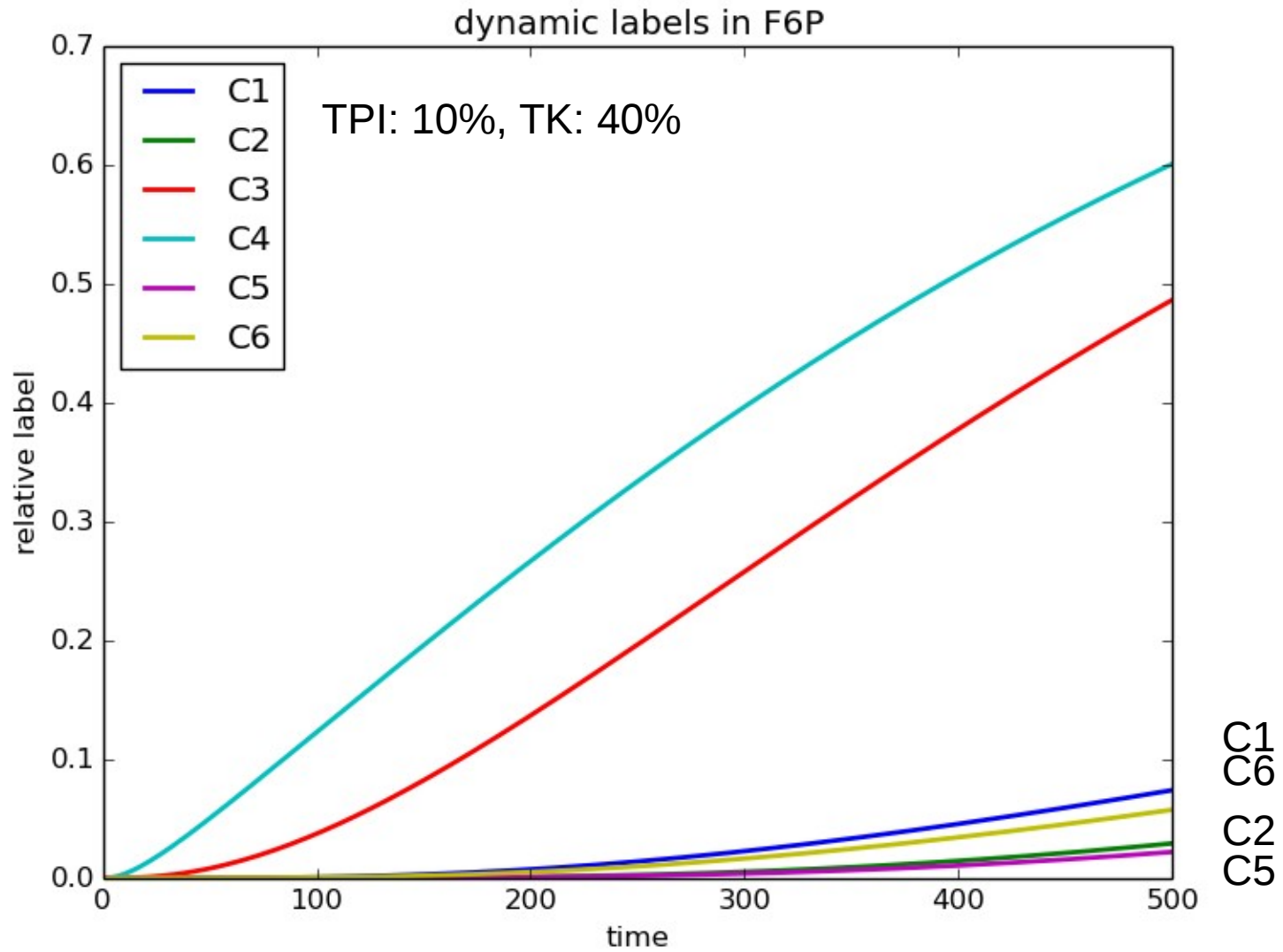

Conclusions

A minimal model of the Calvin-Benson-Bassham Cycle. Why bother?

- Modelling is simplification!
 - *“Simplicity is the ultimate sophistication”* (Leonardo da Vinci)
 - Simple designs allow for general conclusions and deeper understanding
- A (stable) minimal model serves as an easy-to-use module
 - more complex metabolic models
 - link with photosynthetic electron transport chain models
- Forms the basis for exploring dynamic isotope labelling
 - The Gibbs effect can be easily explained
 - It is an emergent property of the CBB cycle
 - We can understand which processes influence label dynamics

Thank you

Collaborators:

Experiments: Martin Steup (Potsdam)
Sebastian Mahlow
Sam Zeeman (Zurich)
Barbara Pfister
Rob Field (Norwich)
Mike Rugen
Douglas Murray (Tsuruoka)

Theory: Önder Kartal (Zurich)
Alexander Skupin (Luxemburg)

Financial Support



Bundesministerium
für Bildung
und Forschung



Internet: <http://qtb.hhu.de>

Public wiki: <http://wiki.hhu.de/>

Software & Models: <http://github.com/QTBI-HHU>



@qtbduesseldorf

Food for thoughts

It appears that metabolism is organised as an interplay of 'entropic' and 'energetic' enzymes

- Why?
- Are there principles behind this organisation?
- How is this connected to resource allocation?

Solving the equilibrium module

3 equations with 3 unknowns:

$$\begin{aligned}
 P_1 &= x_0 \left(f_0 + \kappa_2 f_2 z + \kappa_4 f_4 z^2 \right) + 2g x_0^2 + g_1 x_0 x_1 \\
 P_2 &= x_1 (1 + \kappa_3 z) + g_1 x_0 x_1 \\
 Q &= x_0 (2f_2 \kappa_2 z + 4f_4 \kappa_4 z^2) + x_1 (1 + 3\kappa_3 z) + g_1 x_0 x_1
 \end{aligned}$$

Notation:

x_k : compound with $k+3$ carbons

$$\Rightarrow x_{k+2} = x_k \cdot e^{-\Delta\mu} \cdot z$$

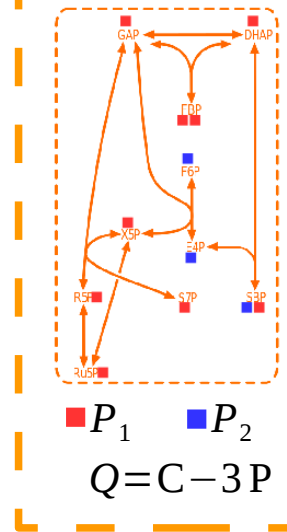

Necessary condition: $P_2 < Q < 4P_1 + 3P_2$

What happens at the extremes?

$Q \rightarrow P_2$: accumulation of small sugars

$Q \rightarrow 4P_1 + 3P_2$: accumulation of large sugars

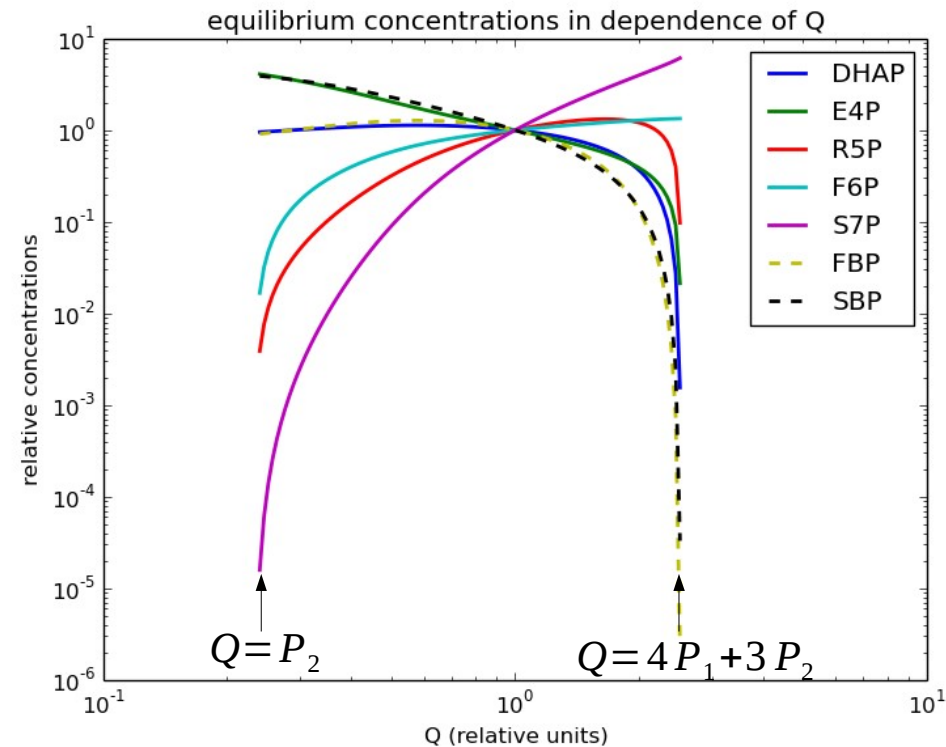

Back to the real world

What happens if the rapid equilibrium is not *exactly* fulfilled?



- Model the fast reactions as mass-action
- Tune the time-scale separation with one parameter

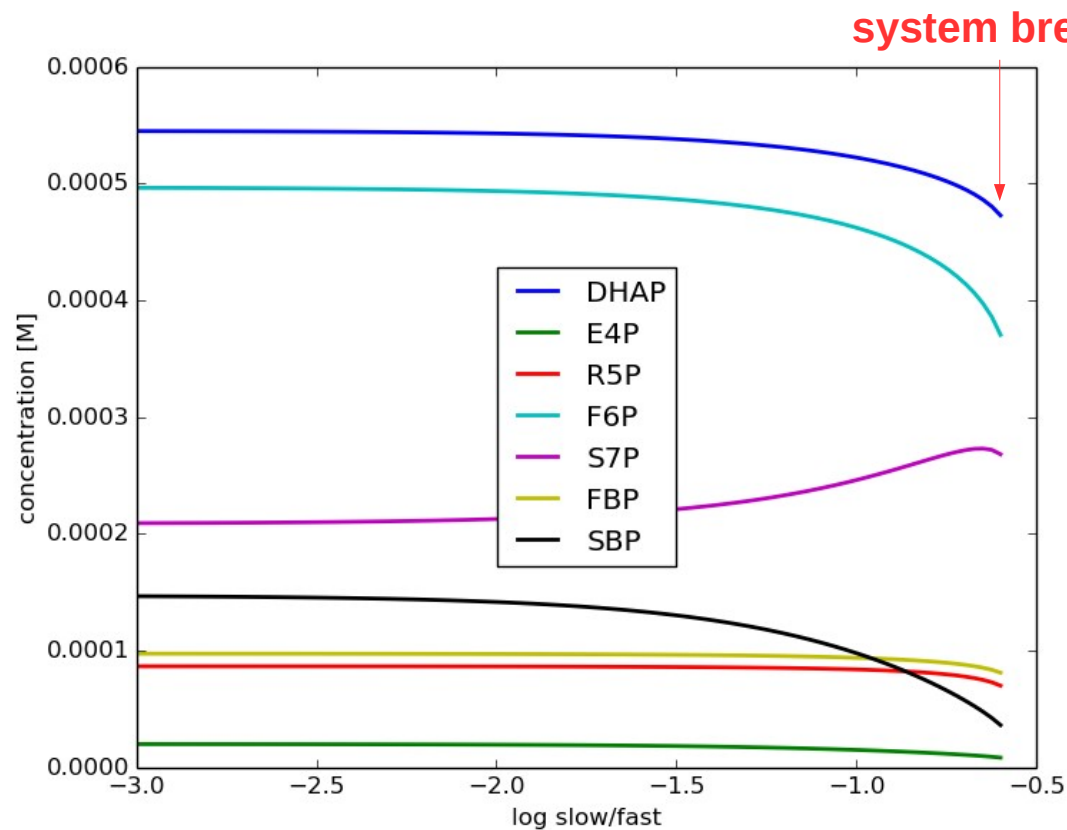

When time-scales are not clearly separated, other regulatory mechanisms are necessary!

rapid equilibrium

similar time-scales

Displacement from equilibrium

The lowest ΔG is just -0.5 kcal/mol!

But Bassham measured -1.4...

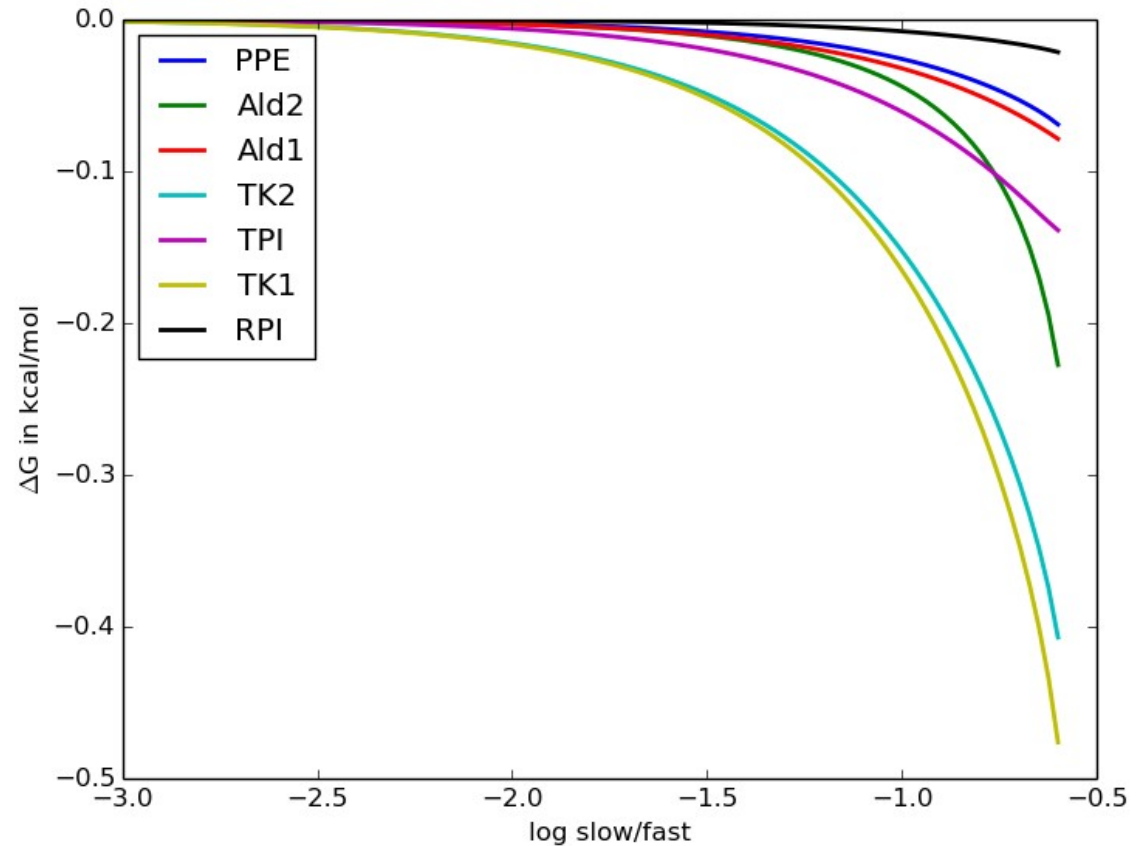

Total Gibbs free energy above equilibrium

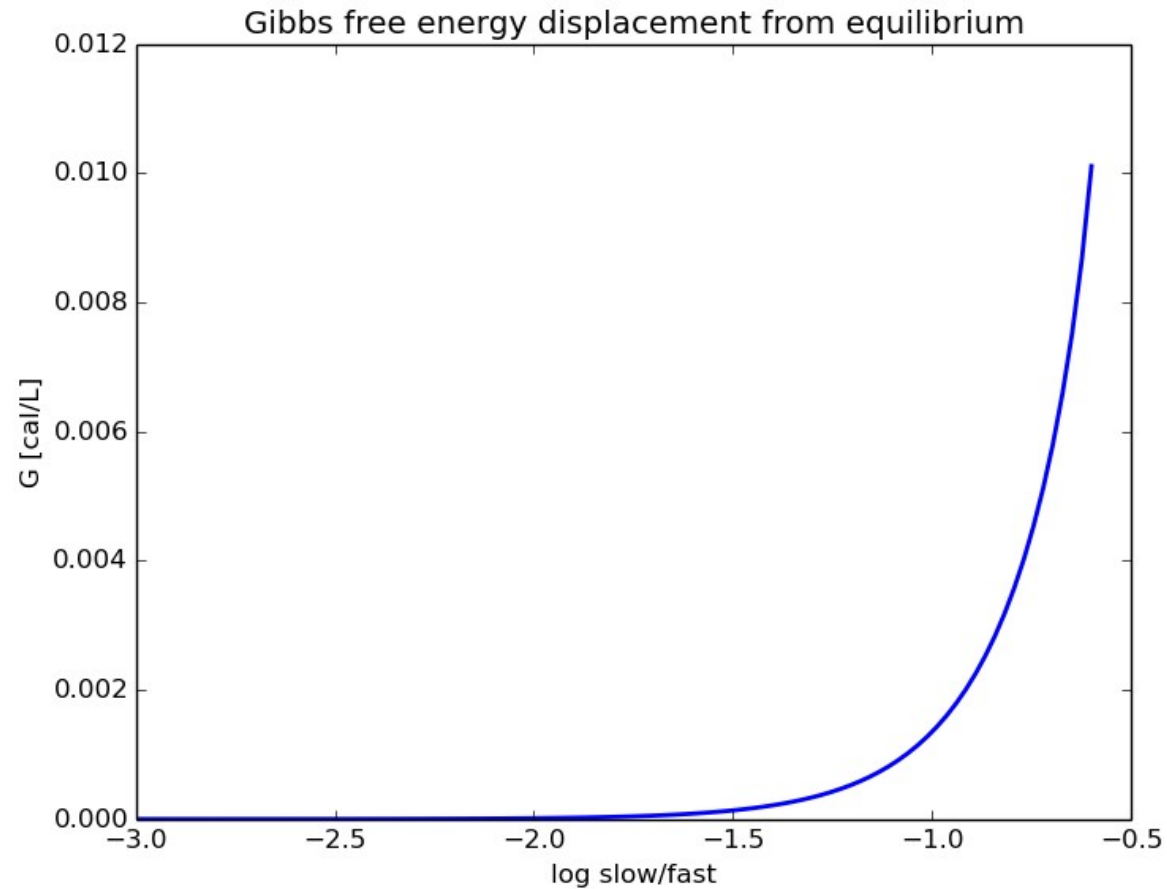

$$G = \sum_{j \in M} x_j \mu_j + RT \cdot \sum_{j \in M} x_j \cdot (\ln x_j - 1)$$

Losing control

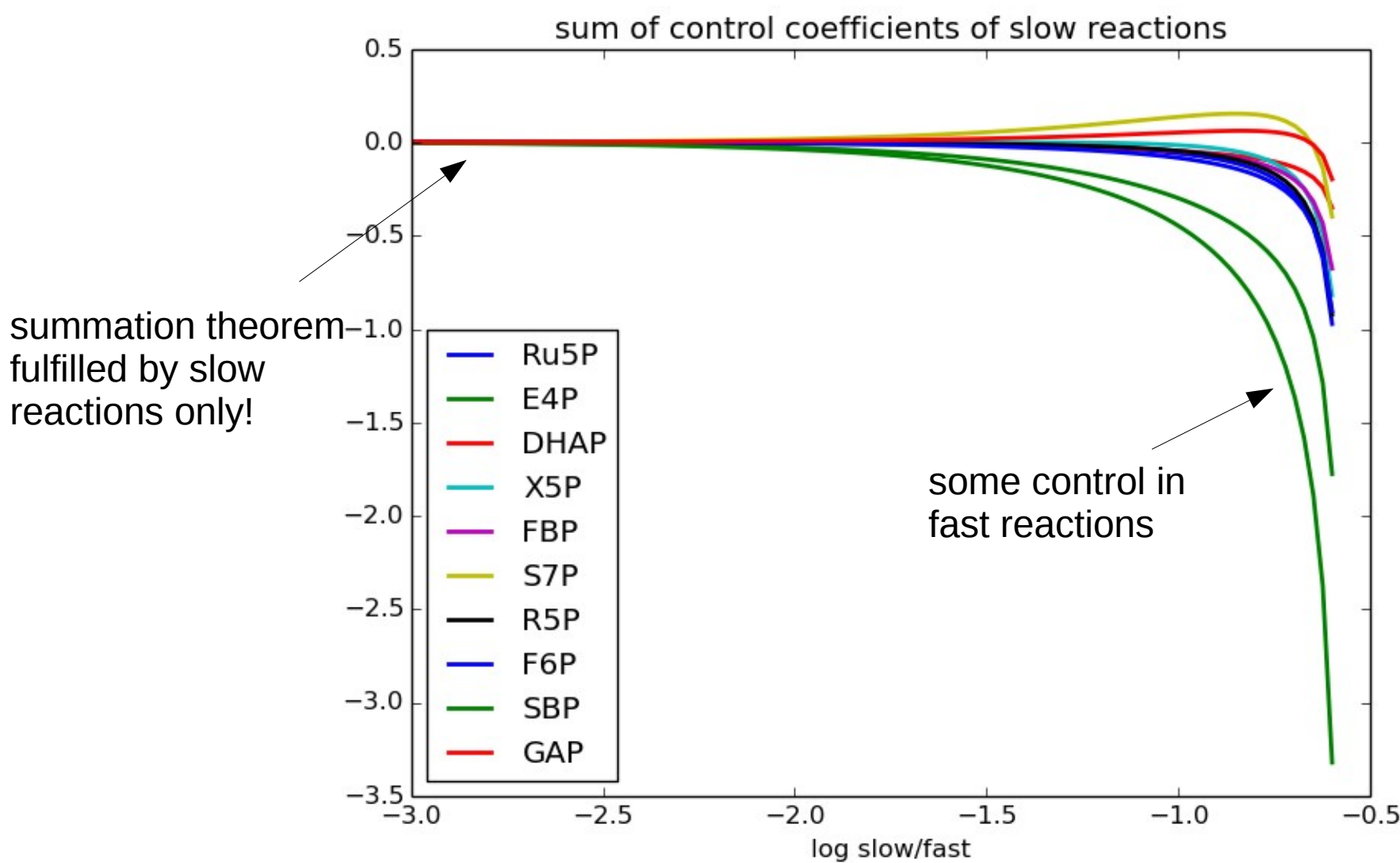

The positive control of SBPase

Accelerating SBPase increases its substrate!!

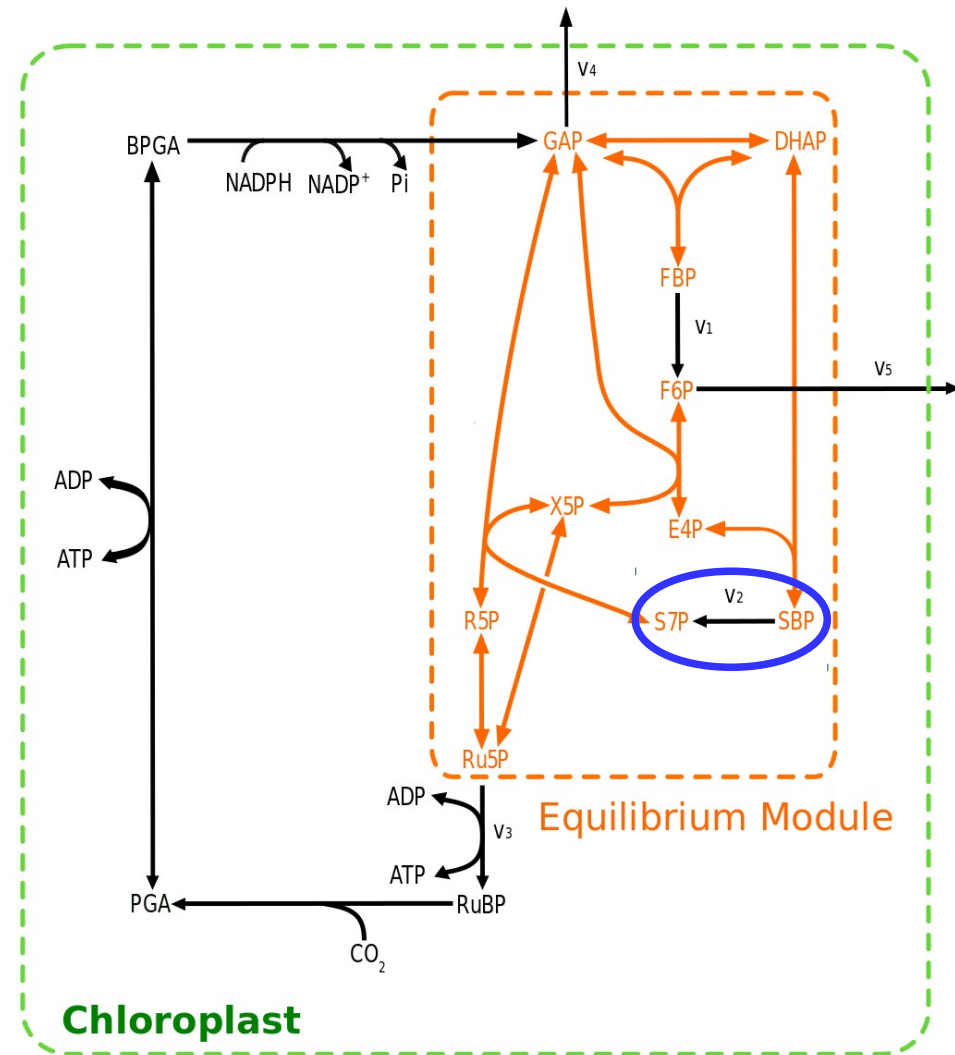
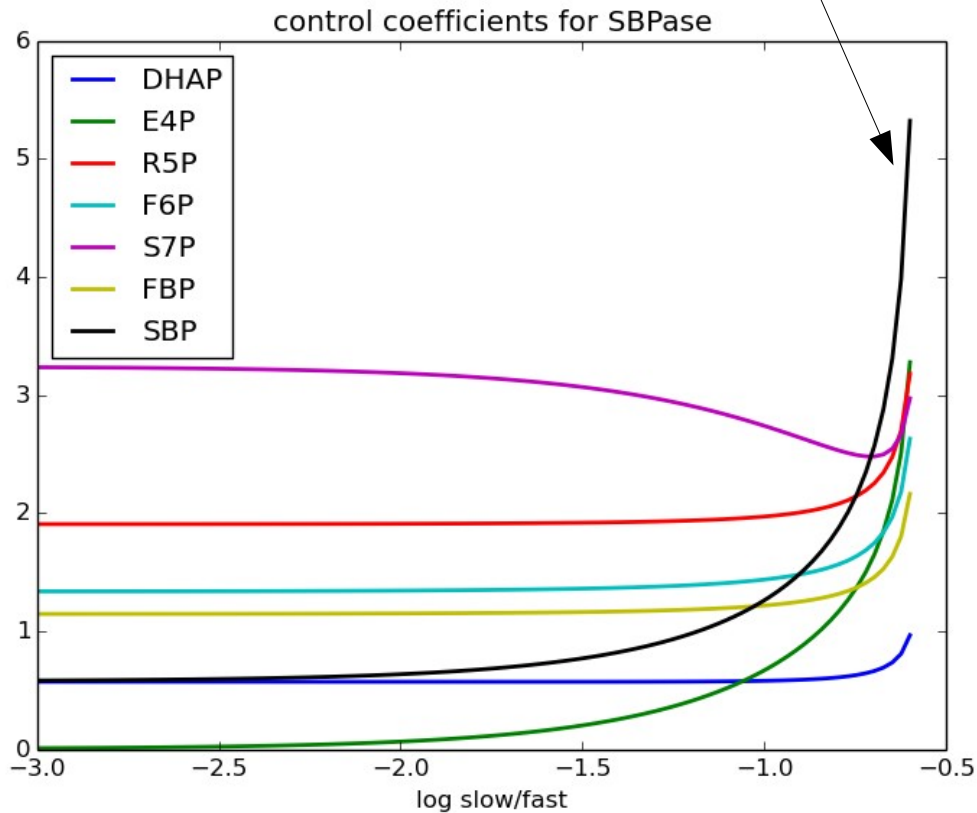

The positive control of SBPase

Accelerating SBPase increases its substrate!!

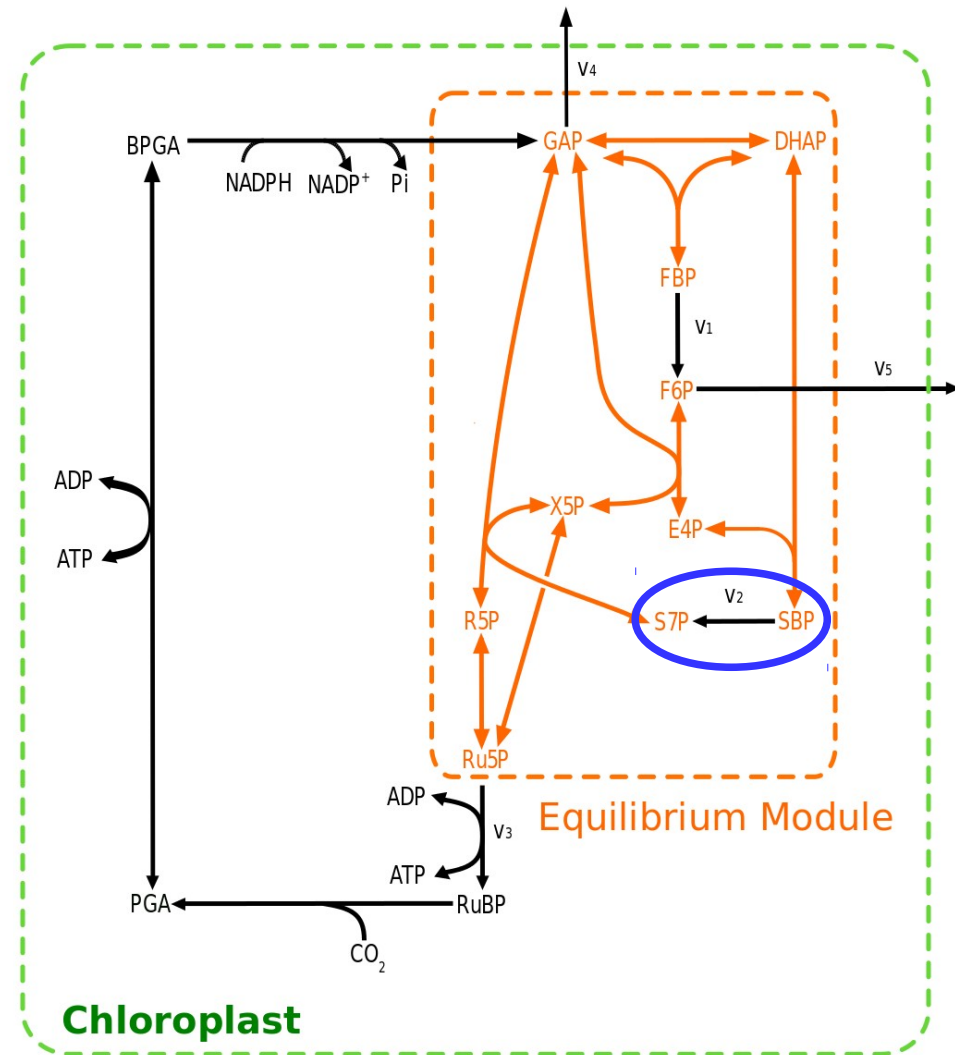
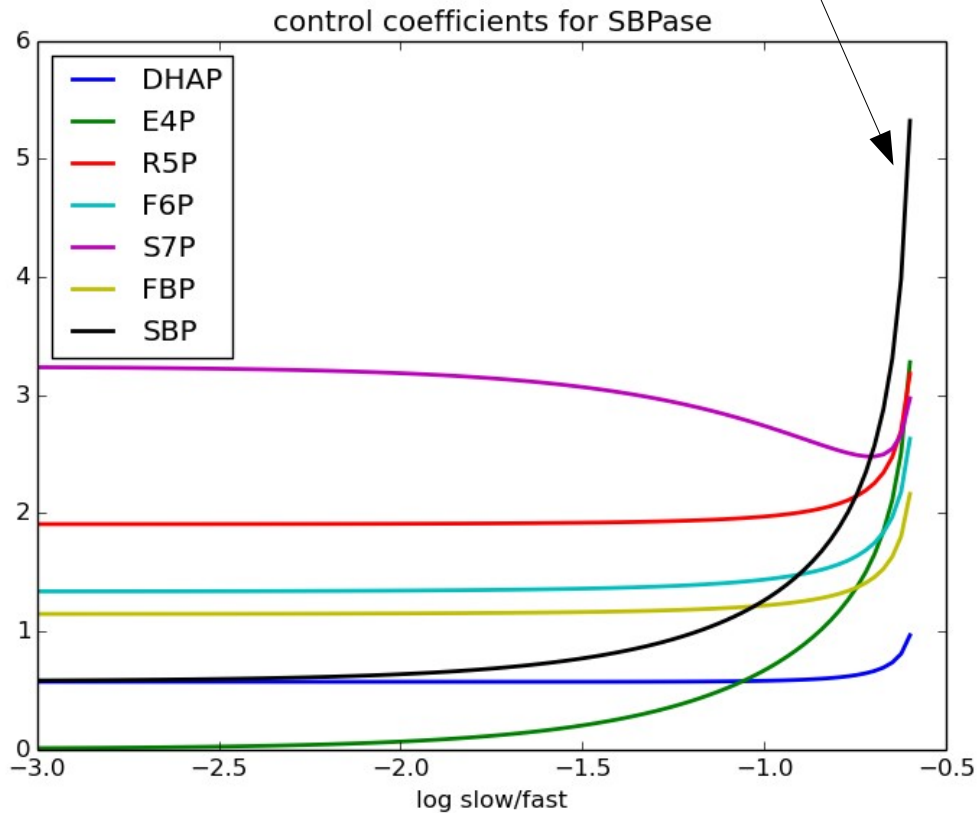

➡ positive feedback! Stability problem...